

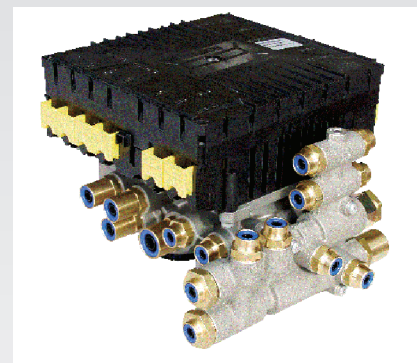

Trykkluftutstyr



Trykkluftutstyr

Innholdsfortegnelse

Wabco kompressorer	3
Wabco luftbearbeiding.....	7
Lufttanker	17
Wabco bremsestyringsenheter.....	20
ABS / EBS Brake control.....	37
Wabco Actuatorer.....	52
Kontrollenheter luftfjæring	60
Elektronisk kontroll av luftfjæring.....	64
Trailer connection	73
Drive Line Control.....	77
Utstyr til busser.....	80
Enheter for universelt bruk	82
Knorr trykkluftutstyr.....	92
Haldex	121
Raufoss forskruvninger	125
Raufoss forskruvninger ABC	143
Bremserør / Slinger	150
Spiralslanger	152
WestFrost	153

Wabco kompressorer

Kompressorer ensylindret

WABCO

Kompressorer en sylindret

Material (no)	Material korttekst
4111416407	Kompressor 1 sylindret luftkjølt 159 cm ³ 3000 1/min 18 bar
4111418450	Kompressor 1 sylindret luftkjølt 159 cm ³ , 3000 1/min 18 bar
4111438050	Kompressor 1 sylindret luftkjølt 293 cm ³ , 3000 1/min 10 bar
4111438450	Kompressor 1 sylindret luftkjølt 159 cm ³ , 3000 1/min 10 bar
4111440030	Kompressor 1 sylindret luftkjølt 106cm ³ , 3000 1/min 14 bar
4123520057	Kompressor 1 sylindret vannavkjølt 352 cm ³ 3000 1/min 12,5 bar

4111415030



4123520020



411 144 003 0



Kompressorer tosylindret

Kompressorer dobbelt sylinder

Material (no)	Material korttekst
4127040087	Kompressor 2 sylindere 704 cm3 vannavkjølt 3000 1/min 5 hull flens
4127040130	Kompressor 2 sylindere
4127040147	Kompressor 2 sylindere
4127040167	Kompressor 2 sylindere
4127040187	Kompressor 2 sylindere 704 cm3 vannavkjølt 3000 1/min 3 hull flens VOLVO
4127040197	Kompressor 2 sylindere 704 cm3 vannavkjølt 3000 1/min
4127049322	Reperasjonsenhet 412 704 001/004/008
4127049332	Reperasjonsenhet 412 704 000/006/010/011/012/014/015
4127049342	Reperasjonsenhet 412 704 002/007/013
4127049362	Reperasjonsenhet 412 704 013 /016
9125120067	Kompressor 2 sylindere 636 cm3 vannavkjølt, 3000/1 min,5 hull flens VOLVO
9125120080	Kompressor 2 sylindere 636 cm3 vannavkjølt, 3000/1 min, 3 hull flens VOLVO
9125129252	Reperasjonsenhet 912 512 006/007
9125129262	Reperasjonsenhet 912 512 008 0 912 514 003/004 912 542 002 0 912 551 002 0

1

4126360010

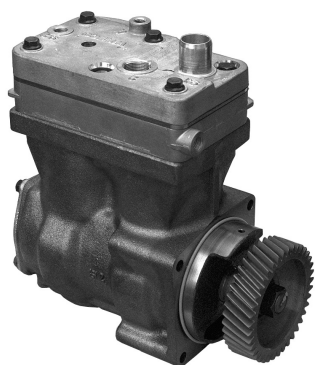

Kompressor unit

Kompressor unit

Material (no)	Material korttekst
4154031050	Kompressor IVECO Kun kompressor
4154034020	Kompressor IVECO Daily komplett unit
4154031000	Kompressor BMW 5 serie - (E39) Touring 1997-2008
4154031060	Kompressor Audi A6 Allroad 1999 - 2005 4Z7616007

4154033040

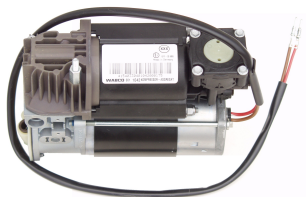

Trykkregulatorer

Trykkregulatorer

Material (no)	Material korttekst
9753030407	Trykkregulator 7.3±0.2 bar 22x1,5mm
9753030710	Trykkregulator 8.5±0.2 bar 22x1.5mm
9753034737	Trykkregulator 8.1±0.2 bar 22x1,5mm
9753034470	Trykkregulator 7.3±0.2 bar 22x1,5mm erst.9753001110
9753034747	Trykkregulator 8.1±0.2 bar 22x1,5mm Dekkluftport
9753030720	Trykkregulator 8.5±0.2 bar 22x1,5mm
9753030890	Trykkregulator 9.5±0.2 bar 22x1,5mm Justerbar
9753030002	Rep sett 303 020,040-043,060,071,076,080,086,088,100,120,121,140,220,221,223,260,261
9753030012	Rep Sett 975 303 400,401,420, 440,449,460,461,463, 482,490,491,492,494,500,504,540,541,580, 660,663
9753035524	Plate

9753030407

975 303 447 0

9753030710



Wabco luftbearbeiding

Et tårns lufttørkere

Single

Material (no)	Material korttekst
4324101910	En kammer lufttørker 12.0±0.2
4324100420	En kammer lufttørker 8.5±0.2 for Voss push-in fittings
4324101040	En kammer lufttørker 8.1±0.2 varmer 894 260 040 2
4324100837	En kammer lufttørker 9.3±0.2 kontakt for Scania
4324100220	En kammer lufttørker 9.5±0.2 varmer 894 260 040 2
4324102017	En kammer lufttørker 8.1±0.2 Patron 432 410 020 2
4324100670	En kammer lufttørker 8.5±0.4 for Voss push-in fittings
4324101027	En kammer lufttørker 8.1±0.2 . M/Regulator
4324251010	En kammer lufttørker el. styrt.Volvo FH, FM Patron 432 901 223 2 Varmer 894 260 049 2
4324251050	En kammer lufttørker el.styrt. Volvo FH, FM Patron 432 901 223 2
4324101440	En kammer lufttørker 9.3±0.2 +Unlod
4324150030	En kammer lufttørker 8.0±0.4 Patron 432 410 020 2 Varmer 894 260 040 2
4324200007	En kammer lufttørker u/regulator. Patron 432 410 020 2
4324209202	Rep sett varmer 432 410 191 0/ 192 0
4324209212	Rep sett for 432 410 003 0, 415 030 0/032 0, 420 003 0
4324219202	Tørke innsats for patron 432 411 020 2, for luft tørker 432 421 003 0
4324259202	Rep sett 432 425 001 0, 004,101
4324259222	Rep sett 432 425 001 0 ,004 0, 101 0 ,105 0, 200 0
4324109322	Rep sett for 432 410 112 0 og 432 425 001 0
4324100022	Rep sett 432410/411/420/421
4324150002	Rep sett for 432 412 001 0, 432 415 000 0,002-006,008,010

432410fo

4324251050

4324101440



APU 9324000240

9324000240

Material (no)	Material korttekst
9324000240	Lufttørke

9324000240



1

To tårns lufttørkere

Doble

Material (no)	Material korttekst
1324075520	To kammer lufttørker Patron 2x 432 406 222 2
4324069202	Luft tørkeinnsett for 432 406 222 2, for luft tørker 432 405/406/408
4324311990	To kammer lufttørker Patron: 2x 432 410 020 2 Ventil:4420191151
4324330020	To kammer lufttørker for Voss 230
4324330620	To kammer lufttørker
4324331080	To kammer luft tørker

4324330060



4324311990



1324075520



Tørke patroner

Filterpatroner

Material (no)	Material korttekst
4324069202	Luft tørkeinnsats for 432 406 222 2, for luft tørker 432 405/406/408
4324102227	Patron for lufttørker 13 bar 39x1.5mm
4324102442	Patron for lufttørker med kullfilter 13 bar 39x1.5 mm Type ASP plus
4324109272	Patron for lufttørker Scania G 1 1/4 med kullfilter, fett og O-ring
4329012232	Patron for lufttørker med kullfilter 39x1.5mm
4329012282	Patron for lufttørker med kullfilter Scania
4329012452	Patron for lufttørker venstre gjenget 39x1,5mm Type ASP Volvo

4324102227

4329012282



Tilbehør lufttørkere

Tilbehør til lufttørkere

Material (no)	Material korttekst
4495150200	Kabel med kontakt 90 grader 2 mtr
8941003532	Kabel med kontakt for to kammer lufttørker 5 mtr
8941000302	Plug, electric
8942600402	Varmeelement 24V Med Termostat
8946004502	Kabel med plugg 24x1mm til solenoid ventil
8946004542	Kabel med plugg 27x1mm 5mtr erstatter 8946004532

4495150200



894100



8942600402

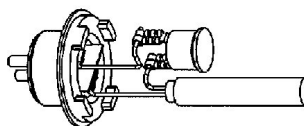

894600



8946002



Sikkerhetsventiler

4346082200

Material (no)	Material korttekst
4346082200	Sikkerhetsventil 10+1,0 bar 16x1,5mm
4346082260	Sikkerhetsventil 15+1,5 bar 16x1,5mm
4346120150	Sikkerhetsventil 8.0+0.9 bar 22x1,5mm
4346120010	Sikkerhetsventil 9,0+0,9 bar 22x1,5mm
4346120640	Sikkerhetsventil 12,0+1,2 bar 16x1,5mm
4346120040	Sikkerhetsventil 13,0+0,8 bar 22x1,5mm

4346120040



1

Frostbeskyttere og vannseparatorer

Frosbeskyttere og vannseparatorer

Material (no)	Material korttekst
4321990300	Frostbeskytter 200 cm ³ maks trykk 20 bar. 22,1,5mm
9320020000	Frostpumpe pumpe uten beholder og styreport innspr. 0,5cm ³
9320021020	Frostpumpe pumpe med beholder 0,5dm ³ uten styreport innspr. 0,2cm ³
9320021000	Frostpumpe med beholder 0,5 dm ³ uten styreport innspr. 0,5 cm ³
9320021010	Frostpumpe med beholder 0,5 dm ³ og styreport innspr. 0,5 cm ³
9320026522	Lokk
4325112204	Filter
4325112224	Filter
4325110002	Rep sett for 432 511 000 0/ 001
8307020874	Wabcothyl 1 Litre
9320020204	Beholder

4321990300



4 - kretsventiler

4-kretsventiler

Material (no)	Material korttekst
9347020002	Rep sett for 934702048,061-068,102,330
9347020427	Ventil 4-Krets 16x1,5/22x1,5mm maks 10 bar 21/22=5,4 bar, 23/24=4,9 bar
9347021920	Ventil 4-Krets 16x1,5/22x1,5mm maks 10 bar 21/22=7,5 bar, 23/24=7,5 bar
9347022217	Ventil 4-Krets 16x1,5/22x1,5mm maks 20 bar 21/22=7,0 bar, 23/24=7,0 bar
9347022607	Ventil 4-Krets 22x1,5mm maks 10 bar 21/22=7,0 bar, 23/24=7,0 bar, for Voss
9347023220	Ventil 4-Krets 16x1,5/22x1,5mm maks 20 bar 21/22=7,0 bar, 23= 7,0bar 24=6,9 bar
9347023227	Ventil 4-Krets 16x1,5/22x1,5mm maks 20 bar 21/22=7,0 bar, 23= 7,0bar 24=6,9 bar
9347023807	Ventil 4-Krets 16x1,5/22x1,5mm maks 20 bar 21/22=7,0 bar, 23/24=7,0 bar
9347023810	Ventil 4-Krets 16x1,5/22x1,5mm maks 20 bar 21/22=6,5 bar, 23/24=6,5 bar
9347023817	Ventil 4-Krets 16x1,5/22x1,5mm maks 20 bar 21/22=6,5 bar, 23/24=6,5 bar
9347050020	Ventil 4-Krets for APU 9325000030/0040
9347050057	Ventil 4-Krets for APU 9325000060/0070/0130/0140
9347141190	Ventil 4-Krets 16x1,5/22x1,5mm maks 13 bar, 21/22=7,5 bar, 23/24=7,5 bar
9347141230	Ventil 4-Krets 16,5x1,5/22x1,5mm maks 13 bar, 21/22=6,9 bar, 23/24=7,2 bar
9347141450	Ventil 4-Krets 16,5x1,5/22x1,5mm maks 13 bar, 21/22=6,5 bar, 23=7,2 bar, 24=6,5 bar,
9347142110	Ventil 4-Krets 16x1,5/22x1,5mm maks 13 bar 21/22=6,5 bar 23=7,4 bar, 24=4,5 bar
9347147400	Ventil 4-Krets 16x1,5/22x1,5mm maks 13 ba, 7 porter 21/22=6,3 bar 23/24=5,8 bar

1

9347050050



9347022607



Overstrømsventiler

Overstrømsventiler

Material (no)	Material korttekst
4341000227	Overstrømventil 22x1,5mm maks 13 bar, CP 4,5 bar justering 0,5-5,2 bar med retur
4341000247	Overstrømventil 22x1,5mm maks 13 bar, CP 6,0 bar justering 5,3-7,0 bar med retur
4341000270	Overstrømventil 22x1,5mm maks 13 bar, CP 0,5 bar justering 0,5-2,5 bar med retur
4341001227	Overstrømventil 22x1,5mm maks 13 bar, CP 4,5 bar justering 0,5-5,2 bar uten retur
4341001237	Overstrømventil 22x1,5mm maks 13 bar, CP 5,0 bar justering 0,5-5,2 bar uten retur
4341001240	Overstrømventil 22x1,5mm maks 13 bar, CP 5,5 bar justering 5,3-7,0 bar uten retur
4341001247	Overstrømventil 22x1,5mm maks 13 bar, CP 5,5 bar justering 5,3-7,0 bar uten retur
4341001257	Overstrømventil 22x1,5mm maks 13 bar, CP 6,0 bar justering 5,3-7,0 bar uten retur
4341001267	Overstrømventil 22x1,5mm maks 13 bar, CP 6,5 bar justering 5,3-7,0 bar uten retur
4341001300	Overstrømventil 22x1,5mm maks 13 bar, CP 7,0 bar justering 5,3-7,0 bar uten retur
4341001307	Overstrømventil 22x1,5mm maks 13 bar, CP 7,0 bar justering 5,3-7,0 bar uten retur
4341001310	Overstrømventil 22x1,5mm maks 13 bar, CP 7,3 bar justering 7,3-8,5 bar uten retur
4341001330	Overstrømventil 22x1,5mm maks 13 bar, CP 7,8 bar justering 7,3-8,5 bar uten retur
4341001390	Overstrømventil 22x1,5mm maks 13 bar, CP 8,5 bar uten retur
4341001430	Overstrømventil 22x1,5mm maks 13 bar, CP 9,0 bar uten retur
4341002207	Overstrømventil 22x1,5mm maks 13 bar, CP 4,5 bar justering 0,5-5,2 bar begrenset retur
4341002227	Overstrømventil 22x1,5mm maks 13 bar, CP 5,5 bar justering 5,3-7,0 bar begrenset retur
4341002280	Overstrømventil 22x1,5mm maks 13 bar, CP 6,4 bar justering 5,3-7,0 bar begrenset retur
4341005040	Overstrømventil 16x1,5mm maks 10 bar, CP 6,7 bar justering 7,3-8,5 bar begrenset retur

4341000227

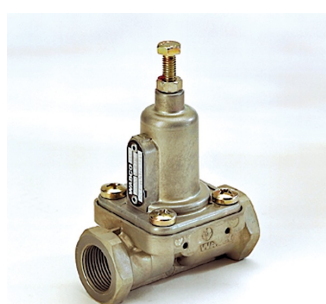

Reduksjonsventiler

Reduksjonsventiler

Material (no)	Material korttekst
4750100007	Trykkbegrensningsventil 22x1,5mm maks 20 bar, ut 7,0 bar, inn 10 bar, justering 6,0-9,0 bar
4750100270	Trykkbegrensningsventil 22x1,5mm maks 20 bar, ut 7,8 bar, inn 10 bar, justering 6,0-9,0 bar
4750100320	Trykkbegrensningsventil 22x1,5mm maks 20 bar, ut 8,5 bar, inn 12,5 bar, justering 6,0-9,0 bar
4750102000	Trykkbegrensningsventil 22x1,5mm maks 20 bar, ut 9,2 bar, inn 12,4 bar, justering 5,8-10,8 bar
4750103000	Trykkbegrensningsventil 22x1,5mm maks 20 bar, ut 8,5 bar, inn 10, bar, justering 5,8-10,8 bar
4750103007	Trykkbegrensningsventil 22x1,5mm maks 20 bar, ut 8,5 bar, inn 10,0 bar, justering 5,8-10,8 bar
4750103010	Trykkbegrensningsventil 22x1,5mm maks 20 bar, ut 10,0 bar, inn 12,5 bar, justering 9,6-12,0 bar
4750103020	Trykkbegrensningsventil 22x1,5mm maks 20 bar, ut 5,3 bar, inn 7,5 bar, justering 1,2-6,2 bar
4750103070	Trykkbegrensningsventil 22x1,5mm maks 20 bar, ut 1,8 bar, inn 8,0 bar, justering 1,2-6,2 bar
4750103120	Trykkbegrensningsventil 22x1,5mm maks 20 bar, ut 5,5 bar, inn 7,5 bar, justering 1,2-6,2 bar
4750150010	Trykkbegrensningsventil 16x1,5mm maks 20/16 bar, ut 7,4 bar, inn 16,0 bar, p1 maks 20 bar (konstant)
4750150040	Trykkbegrensningsventil 16x1,5mm maks 10 bar, ut 3,5 bar, inn 8,0 bar
4750150090	Trykkbegrensningsventil 16x1,5mm maks 20/8 bar, ut 5,3 bar, inn 8,0 bar, p1 maks 20 bar (konstant)
4750150630	Trykkbegrensningsventil 16x1,5mm maks 20/10 bar, ut 8,5 bar, inn 12,0 bar, p1 maks 20 bar (konstant)
4750150720	Trykkbegrensningsventil 16x1,5mm maks 15/12,5 bar, ut 8,5 bar, inn 11,0 bar
4750155000	Trykkbegrensningsventil 16x1,5mm maks 20/10 bar, ut 6,5 bar, inn 8,5 bar, p1 maks 20 bar (konstant)

1

4750103000

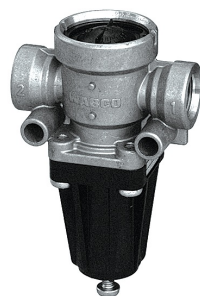

4750100010



4750150010



Lufttanker

Lufttank stål

Trykkluftstanker i stål.
 Norm: EN 286-2.
 Temperaturbestandig - 50° to + 100 °C.
 Arbeidstrykk 10 til 19 bar.
 Tanker med annen kapasitet, diameter og lengde kan skaffes ved forespørsel.
 Leveringstid må påregnes.



Material (no)	Kapasitet (L)	Diameter Ø (mm)	Lengde (mm)	Porter	Gjenge	Maks trykk	Ref.nr.	Festebånd
451/10	10	206	368	4	M 22x1.5	15.5 bar	9504100040	125600206
451/15	15	206	527	4	M 22x1.5	15.5 bar	9504150050	125600206
451/20	20	206	691	4	M 22x1.5	15.5 bar	9504200030	125600206
451/20-246	20	246	495	4	M 22x1.5	15.5 bar	9505200030	125600246
451/25-246	25	246	601	4	M 22x1.5	15.5 bar	9505250010	125600246
451/30	30	246	709	4	M 22x1.5	15.5 bar	9505300020	125600246
451/40	40	276	758	4	M 22x1.5	14.5 bar	9507400020	125600276
451/60	60	310	893	4	M 22x1.5	12.5 bar	9500600030	125600310
451/80	80	396	750	4	M 22x1.5	12.5 bar	9500800020	125600396

1

Lufttank aluminium

Trykkluftstanker i aluminium.
 Norm: EN 286-2
 Temperaturbestandig: -50° ... +65°C
 Tanker med annen kapasitet, diameter og lengde kan skaffes ved forespørsel.
 Leveringstid må påregnes.



Material (no)	Beskrivelse	Kapasitet (L)	Diameter Ø (mm)	Lengde (mm)	Porter	Maks trykk	Ref.nr.
451/5	Tank med braketter	5	152	356	2 (1+1)		030515215B
451/20A		20	246	505	3 (1+2)		0302024615C
451/60A-310		60	310	906	4	11.0	9509600020

Festebånd for lufttanker

Tankbånd

Material (no)	Kapasitet (L)	Diameter Ø (mm)	Ref.nr.
125600206	10/20	206	4519992062
125600246	20/30	246	4519992462
125600276	40	276	4519992762
125600310	60	310	4519993102
125600396	80	396	4519993962



1

Tankbånd todelt

Material (no)	Kapasitet (L)	Diameter Ø (mm)
9505153512	30	246
9507203512	40	276
9509493512	60	310



Underprofil for tankbånd

Material (no)	Beskrivelse	Material	Enhet
125900000	Underprofil for tankbånd	Gummi	M

Dreneringsventiler

Dreneringsventiler

Material (no)	Material korttekst
9343000030	drenerings Ventil (Bruk 7787)
7787	Dreneringsventil luft m/ring M22
9343000010	Tankventil M22X1,5 76.249-00
9343010000	Vannutskiller 22X1,5 Automat

9343000010

9343010000

9343000030



Wabco bremsestyringsenheter

Fotbremseventil enkeltkrets

Hydraulisk styrte

Material (no)	Material korttekst
4674061010	Ventil fotbremse hydraulisk

Trykkluft

Material (no)	Material korttekst
4611061000	Fotbremseventil 2stk 22x1,5mm, pedal 35 grader T-Pl 35 enkeltkrets
4611061020	Fotbremseventil 2stk 22x1,5mm, pedal 35 grader T-Pl 35 enkeltkrets
4611061027	Fotbremseventil 2stk 22x1,5mm, pedal 35 grader T-Pl 35 enkeltkrets
4611130010	Fotbremseventil 2stk 16x1,5mm pedal 45 grader T-Pl 45 enkeltkrets
4611060002	Rep sett for 461 106 ...

4611130010

4611061000

4674061010



Fotbremsventiler

Fotbremsventiler

Material (no)	Material korttekst
4613072007	Fot Brems Ventil
4613150022	Rep sett for 461 315/318/324/478
4613150087	Ventil fotbrems maks 10,0 bar porter 8stk 16x1,5mm
4613150420	Ventil fotbrems maks 10,0 bar porter 8stk 16x1.5mm 2 stk 12x1.5mm
4613151807	Ventil fotbrems maks 9,0 bar integrert demper
4613152580	Ventil fotbrems maks 10,0 bar porter 4stk 22x1,5mm Voss
4613160020	Ventil fotbrems maks 10,0 bar porter 8stk 16x1.5mm 2stk 12x1.5mm
4613170000	Fotbremsventil, pedal 35 grader porter 4stk 16x1.5mm 2stk 12x1.5mm
4613170080	Fotbremsventil, pedal 30 grader porter 4stk 16x1.5mm 2stk 12x1.5mm
4613170090	Fotbremsventil, pedal 30 grader porter 4stk 16x1,5mm
4613185510	Fotbremsventil pedal 43 grader porter 4stk 22x1,5mm Voss 230
4613186040	Fotbremsventil pedal 30 grader porter 8stk 16x1,5mm
4613189242	Rep sett for 461 313/314/ 317/318
4613190042	Rep sett for 461 319 250 0 / 280 0
4613192600	Ventil fotbrems 4stk 22x1,5mm porter 4stk 16x1,5mm Voss 230 integrert lasteventil

461307



4613160020

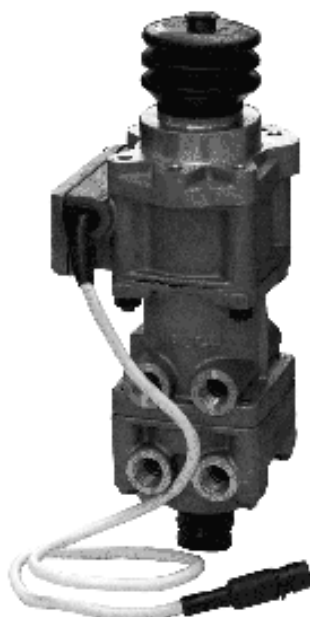

4613170000



4613185510



4613192600
4613150080



4613072000



Håndbremsventiler

Håndbremsventiler

Material (no)	Material korttekst
9617011007	Håndbremsventil aktiviseres 84 grader hø. p.posisjon 84 grader
9617020012	Rep sett for 961 702
9617020504	Support sheet
9617026214	Stempel
9617210007	Håndbremsventil
9617210020	Håndbremsventil I:15 O:8 Bar
9617210042	Rep sett for 961 721
9617210280	Håndbremsventil
9617210410	Håndbremsventil
9617221507	Håndbremsventil Iveco
9617222580	Handbremsventil Iveco
9617223147	Håndbremsventil Scania
9617223240	HåndbremsventilVolvo FL M14X1,5
9617224522	Hood Mercedes
9617232040	Handbremsventil
9617232127	Handbremsventil Volvo FH
9617232150	Håndbremsventil Volvo FH

1

9617011000

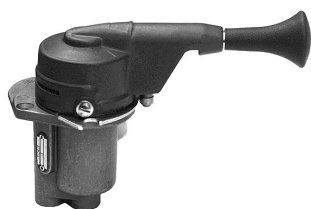

9617221500



9617222580



9617232040



Rele ventiler

Rele ventiler

Material (no)	Material korttekst
9730010002	Rep sett for 973 001 000/ 010/ 011/ 012/ 014/ 020
9730010100	Releventil maks 8 bar. Port 1,2,4=22x1,5mm
9730010107	Releventil maks 8 bar. Port 1,2,4=22x1,5mm
9730010130	Releventil maks 8 bar. Port 1,2,3,4=22x1,5mm
9730010207	Releventil maks 10 bar. Port 1=22x1,5mm, port 2,4=16x1,5mm
9730030007	Releventil maks 10 bar Port 1,2,41=22x1,5mm
9730030070	Releventil maks 10 bar Port 1,2,3,41=22x1,5mm MAN
9730060030	Releventil maks 10 bar Port 1,2=22x1,5mm port 4=16x1,5mm port 3 med demper. Voss 230
9730110000	Releventil maks 10 bar Port 1,2=22x1,5mm port 4=16x1,5mm
9730110002	Rep sett for 973 011 000/001/002/004/021/028/102/104/200/203/204/205
9730110007	Releventil maks 10 bar Port 1,2=22x1,5mm port 4=16x1,5mm
9730110027	Releventil maks 10 bar Port 1,2=22x1,5mm port 4=16x1,5mm Voss 230
9730110500	Releventil maks 13 bar Port 1,3=22x1.5mm port 2,4=16x1.5mm uten retur Scania
9730111090	Releventil DAF
9730112000	Releventil maks 10 bar Port 1=22x1.5mm Port 2=22x1.5mm Port 4=16x1.5m Port 42=16x1.5 ACF
9730112010	Releventil maks 10 bar Port 1,3,21,22=22x1,5mm port 4=16x1,5mm ACF
9730112030	Releventil maks 10 bar Port 1,2= 22x1.5mm Port 41,42=16x1.5mm Iveco ACF
9730112050	Releventil maks 10 bar Port 1,2=22x1.5mm Port 3: med demper Port 4=16x1.5mm ACF
4730170000	Releventil maks 10 bar Porter= 22x1,5mm ACF
4730170002	Rep sett for 473 017 000/002/004/005/007 ACF

9730010100



9730030000



9730110000



9730112000



Manuell lastkjennende ventil

Manuell

Material (no)	Material korttekst
4756040130	Lastkjennende ventil manuel uten slipposisjon
4756040117	Lastkjennende ventil manuel med slipposisjon
4756040137	Lastkjennende ventil manuel uten slipposisjon
4756040022	Rep sett for 475 604 010/011/012/013/015/017/019/041/043/050

4756040130



4756040130

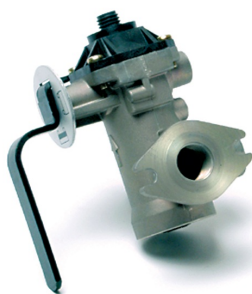

Automatisk lastkjennende ventiler

Lastkjennende ventiler

Material (no)	Material korttekst
4757010010	Lastkjennende ventil 30Gr Bil
4757017122	Lastkjennende ventil
4757100022	Rep sett for 475 710 011/128/129/136/137
4757100207	Lastkjennende ventil 30° 16x1,5mm
4757100360	Lastkjennende ventil 30° 16x1,5mm for Voss230
4757120000	Lastkjennende ventil med arm 20 grader
4757120007	Lastkjennende ventil med arm 20 grader
4757130002	Rep sett for 475 713 000/500/501
4757130020	Lastkjennende ventil med arm 30 grader 22x1,5mm/16x1,5mm
4757135000	Lastkjennende ventil med arm 20 grader 22X1,5mm, 16X1,5mm
4757135007	Lastkjennende ventil med arm 20 grader 22X1,5mm, 16X1,5mm
4757135010	Last kjennende ventil med arm 33 grader 16x1,5mm/22x1,5mm
4757137102	Arm med wire og fjær for 4757135000
4757200050	Last kjennende ventil
8991446304	Skilt ALB mekanisk
8991446314	Skilt ALB luft

1

4757010010

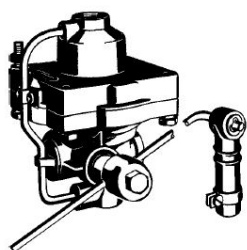

4757017122

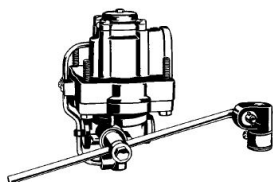

4757100200



4757120007

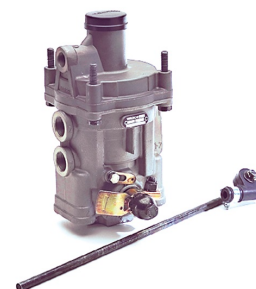

4757135007

4757137102

8991446304

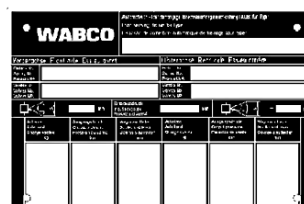
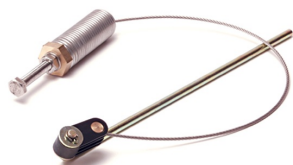
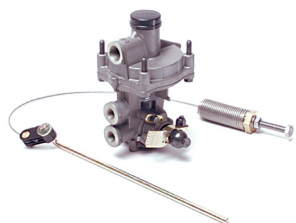

Fjærarm



Fjærarmer

Material (no)	Material korttekst
4333020020	Fjærarm L 260 m/ gummiledd
4333020000	Fjærarm L 260 m/ kuleledd
4333060020	Fjærarm L 260
4333060030	Fjærarm L 260

Lastkjennende ventiler Pneu

Lastkjennende ventiler Pneu

Material (no)	Material korttekst
4757000032	Rep sett for 475 700 120/149/220/230/???263???/265/293/294/295/?297
4757000042	Rep sett for 475 700 320/331/334/340/350-353/395-399/401/403/410/411/430/431
4757002200	Alb. P4=4,25 M22X1,5
4757002207	Last kjennende ventil
4757020200	Alb. M/Justerbart Anslag
4757110027	Lastkjennende ventil
4757110037	Lastkjennende ventil
4757110090	Lastkjennende ventil Volvo 1606791
4757110240	Lastkjennende ventil Mercedes
4757110740	Lastkjennende ventil Volvo manøvertrykk 0,5-5,0Bar
4757145000	Lastkjennende ventil 8T
4757145007	Lastkjennende ventil
4757145090	Lastkjennende ventil for luftfjæring 0,7-4,7Bar
4757145097	Lastkjennende ventil for luftfjæring 0,7-4,7Bar
4757145302	Fjærsats for lastkjennende ventil
4757146000	Lastkjennende ventil
8991446304	Skilt ALB mekanisk

1

4757002207



4757110020



Lastkjennende katastrofeventiler

Katastrofeventiler

Material (no)	Material korttekst
4757155000	Lastkjennende katastrofe ventil manøvertrykk 0,7-3,8 bar
4757155007	Lastkjennende katastrofe ventil manøvertrykk 0,7-3,8 bar

4757155000

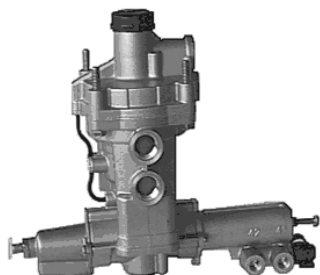

Reguleringsventiler

Reguleringsventiler

Material (no)	Material korttekst
9750010007	Reguleringsventil 0,7 bar 22X1,5mm linjær
9750010017	Reguleringsventil 1,0 bar 22X1,5mm linjær
9750020030	Reguleringsventil ikke linjær
9750020017	Reguleringsventil ikke linjær
9750020050	Reguleringsventil M22X1,5 ikke linjær

9750010000

9750020010



Hurtigløserventiler

Hurtiglåseventiler

Material (no)	Material korttekst
4735010010	Hurtigløserventil 22X1,5mm Volvo
9735000510	Hurtigløser ventil med to-Veis Ventil
9735000000	Hurtigløser ventil med 2 uttak 22x1,5mm MB, Volvo
9735000380	Hurtigløser ventil med 4 uttak 16x1,5mm, 22x1,5mm

9735000000



9735000380

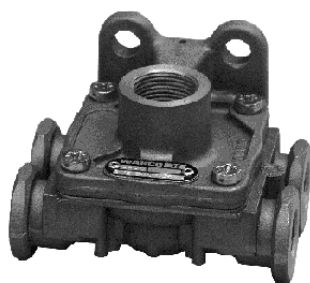

9735000510



Hengerkontroll ventiler

Hengerventiler

Material (no)	Material korttekst
4710030207	Bremseventil
4712001100	Tilhenger Styreventil
9730020130	Rele M22X1,5
9730024037	Releventil M16X1,5
9730024020	Releventil M16X1,5
9730025217	Releventil M16X1,5
9730020052	Rep Sett
9730025207	Styreventil
9730020007	Tilhenger Styreventil
9730025397	Tilhenger Styreventil
9730025387	Tilhenger Styreventil
9730024030	Tilhenger Styreventil
9730024250	Tilhenger Styreventil
9730022222	Utluftingsstykke

1

4710030200



4712001100



9730020000



9730025390



Tilhenger katastrofe ventiler

Tilhenger katastrofeventiler

Material (no)	Material korttekst
4006000100	Bremseventil tilhenger
9710020002	Rep.Sett.Nytt Nr.8901584452
9710020007	Styreventil
9710020032	Rep Sett
9710021520	Styreventil M16X1,5/M22X1,5
9710021527	Rele Katastrofe Ventil
9710023000	Tilhenger Bremseventil
9710023007	Rele Katastrofe Ventil
9710023010	Tilhengerbremseventil
9710029000	Tilhenger bremseventil med Rang og Parkventil
9710029252	Rep sett PRE Ventil
8901584452	Rep-Sett. Se Også 9710020002
9710029007	Tilh.Bremseventil med Rang Og Parkvent
9710021507	Tilhengerbremseventil M/Forbr.

9710020007

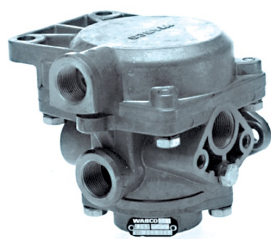

9710023007

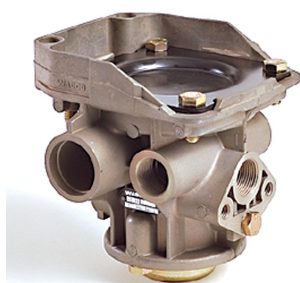

9710029000



9710021507

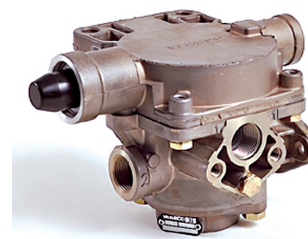

Compact unit

Compact unit

Material (no)	Material korttekst
9213999262	Reparasjons enhet
9213990160	Servo 60 Cm3 M Reservoar Erst.420103

9213990160

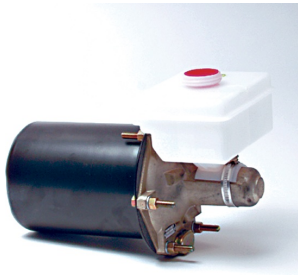

Utløserventiler

Utløserventiler

Material (no)	Material korttekst
4630340000	Ranger / utløserventil M22X1,5
4630340050	Ranger / utløserventil M/Brakett
9630010007	Ranger / utløserventil
9630010130	Ranger / utløserventil M22X1,5
9630010520	Ranger / utløserventil Park/Shunt
9630010510	Ranger / utløserventil Park/Shunt
9630010167	Ranger / utløserventil
9630010137	Ranger / utløserventil
9630010127	Ranger / utløserventil
9630010517	Ranger / utløserventil
9630060017	Ranger / utløserventil parkeringsbrems M 16x1,5
9630060030	Ranger / utløserventil parkeringsbrems M16X1,5 Rød
9630060060	Ranger / utløserventil parkeringsbrems

9630010130



9630010520

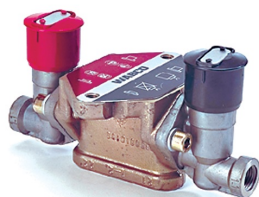

9630060017



9630060030



Trykkreduksjonsventiler Empty load

Trykkreduksjonsventiler

Material (no)	Material korttekst
4733000030	Last-/Leerventil 2,0:1 M22X1,5
4733000060	Last-/Leerventil 1,15:1 M22X1,5
4733010020	Trykkreduksjonsventil
4733010030	Trykkreduksjonsventil
9730111090	Releventil DAF
4753040042	Rep Sett

4733010030



9730111000



ABS / EBS Brake control

ABS ECU Bil

ECU Bil

Material (no)	Material korttekst
4460030640	ECU ABS-C 3 6S/6M
4460034030	ECU ABS-D 6S/6M 24V
4460034130	ECU ABS-D 6S/6M 24V
4460040880	ECU ABS-C3 4S/4M 24V
4460044060	ECU ABS-D 4S/4M 24V
4460043200	ECU ABS-D basis 4S/4

4460030640



4460034030



4460043200



ABS Kabel Bil

ABS Kabel bil

Material (no)	Material korttekst
4494151800	Kabel med Kontakt
4494150800	Kabel for magnetventil 8.0mtr rett bajonett
4495150200	Kabel med kontakt 90 grader 2 mtr
4497111000	Kabel
8946004512	Kabel 0.3mtr 27x1mm 90 grader plugg

4494150800

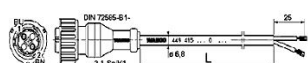

4494151800

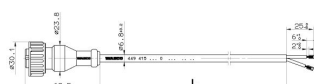

4497111000



ABS ECU Henger

ABS ECU Henger

Material (no)	Material korttekst
4005000820	2S/2M-4S/3M ABS Compact VCSII
4005000830	2S/2M-4S/3M ABS Compact VCSII 12v
4005000810	Vario Compact ABS
4461055372	Lampe grønn med kabel 10.0mtr
4461050134	Hus For Ecas
4461057502	Kompl Skjøt For Kabel
4461050144	Lokk For Abs Elektronikk Integral
4461050124	Lokk For Elektronikk Ny Type
4461055302	Monteringssats System 6S/3M
4461059262	Rep.sett
4461080400	2S/2M Abs Vcs Elektronikk-Enhhet
4461080300	4S/3M Abs Vcs Elektronikk-Enhhet
4461080310	4S/3M Abs Vcs Elektronikk-Enhhet
4461080850	ABS VCS II elektronikk
4461080450	Vcs Elektronikk 4S/2M
4463030050	Infomaster Vcs/EL

1

4005000820



ABS Kabel Henger

ABS Kabel henger

Material (no)	Material korttekst
4491121000	Strømforsyningskabel 10mtr Semi VCS 1 5 pin
4491121200	Strømforsyningskabel 12mtr Semi VCS 1 5pin
4491251200	Strømforsyningskabel 12Mtr Semi VCS II 5 PIN
4491251400	Strømforsyningskabel 14mtr VCS II 5 pin
4491251800	Strømforsyningskabel 18Mtr Semi VCS II 5 PIN
4491261200	Strømforsyningskabel 12Mtr Semi VCS II 7 PIN
4491261400	Strømforsyningskabel 14Mtr Semi VCS II 5 PIN
4491321200	Strømforsyningskabel 12Mtr Semi VCS I / II 5 PIN
4491421200	Strømforsyningskabel 12mtr Vario C Semi 5 pin PG 16 Erst.446010012
4491441570	Strømforsyningskabel 12mtr Semi + Diagnose VCS II 7 pin
4492251200	Strømforsyningskabel 12mtr VCS II slep 5 pin
4492251400	Strømforsyningskabel 14mtr VCS II slep 5 pin
4492331000	Strømforsyningskabel 10mtr VCS I /II Slep 7 PIN
4493201500	Strømforsyningskabel 15mtr VCS II uten støpsel 7 PIN
4493321200	Strømforsyningskabel 12mtr VCS I uten støpsel 5 pin
4493321400	Strømforsyningskabel 14mtr VCS I uten støpsel 5 pin
4493321800	Strømforsyningskabel 18mtr VCS I uten støpsel 5 pin
4493360300	Strømforsyningskabel 3mtr VCS II T ECAS diagnose 6 pin
4493373280	Strømforsyningskabel 3/12mtr VCS II T ECAS diagnose 6 pin
4493401530	ELM kabel + diagnose
4493542530	Diagnosekabel 6/6mtr VCS I Elm
4493743280	Strømforsyningskabel 0.25mtr VCS II 5 PIN 24N
4493861430	Strømforsyningskabel 1mtr VCS II diagnose
4494230090	Magnetkabel Abs 0.7 M
4494230300	Magnetkabel
4494230600	Magnetkabel
4494440220	Kabel Vcs
4495340430	Modulatorkabel A+B 1/1M
4495341480	Kabel med Kontakt, ABS
4495443330	Kabel for tre enkle modulatorer 6/6/1
4496150100	Kabel med Kontakt, ABS
4496150300	Diagnosekabel 3.0M VCSII
4496150600	Diagnosekabel 6m
4496161480	Kabel med kontakt ABS
4496161530	Kabel med Kontakt, ABS
4496161570	Diagnose og modulatorkabel 12/3m
4496161580	Diagnose +modulatorkabel 15/3m
4496172530	Kabel med Kontakt, ABS
4496201560	diagnose+slitasjevarslers+modulatorkabel
4497120080	Sensor forlengningskabel 0,76 mtr
4497120180	Sensor forlengningskabel 1,8 mtr
4497120230	Sensor forlengningskabel 2,3 mtr

Material (no)	Material korttekst
4497120300	Sensor forlengningskabel 3,0 mtr
4497120380	Sensor forlengningskabel 3,8 mtr
4497120400	Kabel med kontakt
4497120510	Sensor forlengningskabel 5,0 mtr
4497120600	Sensor forlengningskabel 6,0 mtr
4497120640	Sensor forlengningskabel 6,35 mtr
4497120700	Sensor forlengningskabel 7,00 mtr
4497120800	Sensor forlengningskabel 8,00 mtr
4497120900	Sensor forlengningskabel 9,00 mtr
4497121000	Sensor forlengningskabel 10,0 mtr
4497121200	Sensor forlengningskabel 12,0 mtr
4497150500	Sensor-Forlengningskabel
4497150800	Sensor-Forlengningskabel
4497151200	Sensor-Forlengningskabel
8946011322	Adapter/overgang fra bajonet til gjenger 0.15mtr kont.24mm

449112

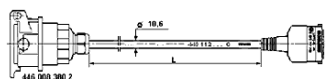

449142

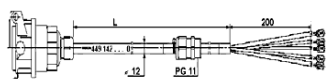

449233

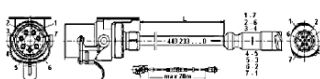

4493861430



4497120080



4497150200



8946011322



Solenoid ventiler

Solenoid ventiler ABS

Material (no)	Material korttekst
4721950090	Magnet modulator Ventil ABS 11 bar 24V 22x1,5mm bayonet kont. (MAN)
4721950430	Magnet Boxer Ventil ABS 10 bar 24V 22x1,5mm bayonet kont. (DIN) sort
4721950580	Magnet modulator Ventil ABS 13 bar 24V 22x1,5mm bayonet kont. (DIN) sort
4721950417	Magnet Boxer Ventil ABS 10 bar 24V 22x1,5mm bayonet kont. (DIN)
4721950317	Magnet modulator Ventil ABS 10 bar 24V 22x1,5mm / 16x1.5mm bayonet kont. (DIN)
4721950180	Magnet modulator Ventil ABS 11 bar 24V 22x1,5mm bayonet kont. (DIN)
4721950970	Magnet modulator Ventil ABS 13 bar 24V 22x1,5mm bayonet kont. (DIN)
4721959202	Reparasjons enhet (ABS sett)
4721959212	Reparasjons enhet

4721950410

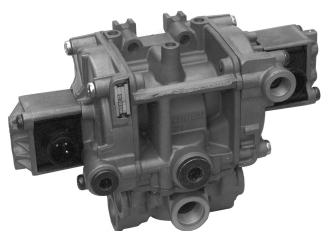

4721950090



4721950310

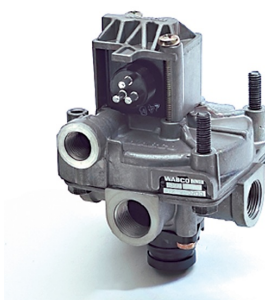

ABS Sensor 441 03.

Speed Sensorer 441 03.

Material (no)	Material korttekst
4410320434	Hette for for sensor socket X5...X10
4410320920	Sensor 3M
4410327050	Inductive sensor med kontakt
4410327210	ABS sensor med kontakt Audi
4410328070	ABS sensor med kontakt lengde 0.4mtr
4410328210	ABS sensor med kontakt lengde 1.26mtr
4410329022	Induktiv sensor
4410329050	ABS sensor rett med kontakt lengde 294mm
4410329200	ABS sensor med kontakt lengde 2.5mtr
4410329202	ABS sensor med kabel
4410329212	ABS sensorsett med kontakt 0.4mtr
4410329222	ABS sensorsett med kontakt 1.0mtr
4410329230	Speed sensor med kontakt 2.2mtr
4410329632	Sensorsett med kontakt rett 350mm
4410329642	Rep sett
4410329672	Sensorsett lengde 2mtr
4410329682	Sensor service sett lengde 1.7mtr

1

4410320920



4410329632



4410329xx2



EBS Bil Bremsesignal transmitter

Bremsesignal transmitter

Material (no)	Material korttekst
4800020040	Brems signal transmitter 10 bar
4800020220	Brems signal transmitter 10 bar

4800200040

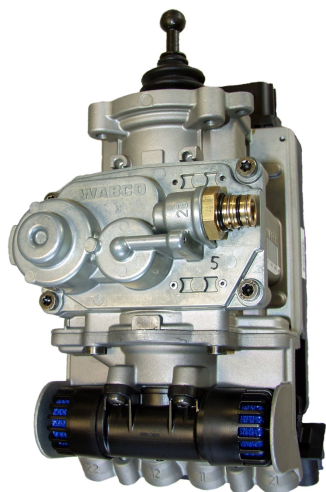

EBS Aksel modulatorer

EBS Aksel modulatorer

Material (no)	Material korttekst
4801030110	EBS-Aksel modulator 4x2 med ESC. MB Axor, Atego/S
4801030120	EBS-Aksel modulator 6x2, 6x2/4, 6x4, 8x4, MB Axor, Atego/S
4801030130	EBS-Aksel modulator 4x2 med ESC. MB Axor
4801030160	EBS-Aksel modulator 6x2, 6x2/4, 6x4, 8x4, MB Actros MP2
4801030410	EBS-Aksel modulator 4x2, DAF FA
4801030610	EBS-Aksel modulator, Bus. MB, Neoman, Neoplan, Solaris
4801040020	EBS-Aksel modulator 6x2 slitasjesensor DAF
4801050070	EBS-Aksel modulator 6x2, 6x2/4, 6x4, 8x4, 3/2 releventil MB, EvoBus

480103b

4801040050

4801050060

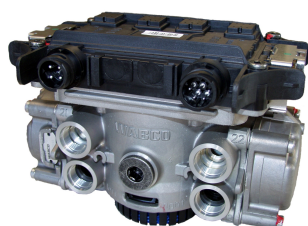

Propotional Relay Valve

Propotional Relay Valve

Material (no)	Material korttekst
472250000	Proportional releventil arb.trykk 5-8 bar porter 12x1,5mm kontakt 27x1mm
4802020040	Proportional releventil arb.trykk 10 bar porter 22x1,5mm 16x1.5mm MB, EvoBus

472250b



480202b

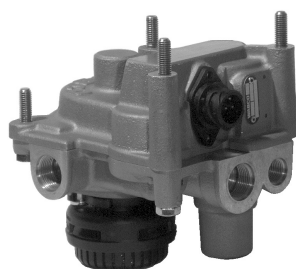

EBS Hengere

EBS Hengere

Material (no)	Material korttekst
4006077180	Ebs-E sett premium m/pem uten nipler erstatter 4801020640/0630
4615130020	PEM (Pneumatic Extension module)
4615139202	Rep.sett for 461513... . og 480102... .
4801020000	EBS trailer modulator erstattes av 480 102 014 0
4801020307	EBS trailer modulator erstatter 480 102 030 0
4801020140	EBS trailer modulorr Rss 4S/3M
4801020150	EBS trailer modulator Tce
4801020310	EBS trailer modulator EBS E1
4801020600	EBS trailer modulator E ver.
4801020607	EBS trailer modulator E ver.
4802070010	EBS releventil

4615130000

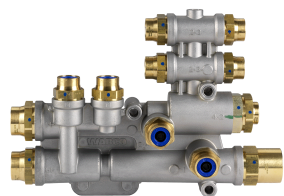

4801020600



4802070010

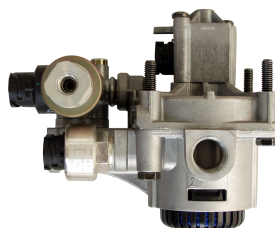

4801020000

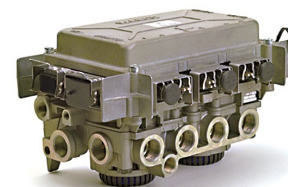

EBS tilbehør henger

EBS tilbehør henger

Material (no)	Material korttekst
4461220530	Wabco CAN-repeater
4461224010	Ultrasonic sensor LIN EBS E2 0 grader
4461224020	Ultrasonic sensor LIN EBS E2 15 grader
4461921100	SmartBoard
4461921110	SmartBoard ADR

4461220530



4461224010



4461921100



EBS Kabel hengere

EBS Kabel hengere

Material (no)	Material korttekst
4491331500	EBS D/E kabel henger 15mtr 7 pin
4491721200	EBS D kabel henger 12mtr 7 pin
4491721300	EBS D kabel henger 13mtr 7 pin
4491721500	EBS D kabel henger 15mtr 7 pin
4491731200	EBS E strømforsyningskabel 12 mtr Semi
4491731500	EBS E strømforsyningskabel 15 mtr Semi
4492331000	Strømforsyningskabel 10mtr VCS I /II Slep 7 PIN
4492331800	Strømforsyningskabel 18mtr Slep 7 PIN
4492721000	EBS kabel 10mtr 7 pin
4492721200	EBS kabel henger 12mtr. med støpsel
4492721500	EBS kabel henger 15mtr. med støpsel
4492731200	EBS E strømforsyningskabel 12 mtr. Slep
4493330030	EBS kabel henger 0.3mtr. 7 pin Bayonett
4493330250	EBS kabel henger 2.5mtr. 7 pin
4493480200	EBS kabel henger 2.0mtr. 4 pin
4493490600	EBS kabel henger 4.0mtr. 4 pin ISO1185 (24N) EBS E
4493500100	Tilkoblingskabel EBS E
4493720800	EBS kabel henger 8.0mtr EBS D
4493721200	EBS kabel henger 12.0mtr EBS D
4493721300	EBS kabel henger 13.0mtr EBS D
4493770300	EBS kabel 3.0mtr EBS D SmartBoard
4493770800	EBS kabel 8.0mtr EBS D SmartBoard
4494290800	EBS rele ventilkabel 8 mtr E-versjon
4494291300	EBS rele ventilkabel 13 mtr E-versjon
4494360800	EBS rele ventilkabel 8 mtr 8 pin
4494430200	Kabel for løfteaksel ventil EBS E 2.0mtr
4494430600	Kabel for løfteaksel ventil EBS E 6.0mtr
4494450500	Kabel magnet ventil EBS E 5.0mtr
4494720300	EBS kabel Rev-Kabel 3mtr
4494720800	EBS kabel Rev-Kabell 8mtr
4494721200	EBS kabel Rev-Kabel 12mtr m/kontakt
4494721300	EBS kabel akselsensor 13mtr
4495350600	EBS kabel 6mtr 4 pin
4496110400	EBS diagnosekabel 4 mtr
4496110600	Diagnosekabel EBS-E
4496110800	Diagnosekabel EBS-E
4496270600	Tilkoblingskabel EBS E
4496280500	Tilkoblingskabel EBS E
4496720400	Ebs Diagnosekabel 4M
4496720600	Ebs Diagnosekabel 6M
4497120080	Sensor forlengningskabel 0,76 mtr
4497120180	Sensor forlengningskabel 1,8 mtr

Material (no)	Material korttekst
4497120230	Sensor forlengingskabel 2,3 mtr
4497120300	Sensor forlengningskabel 3,0 mtr
4497120380	Sensor forlengningskabel 3,8 mtr
4497120400	Kabel med kontakt
4497120510	Sensor forlengningskabel 5,0 mtr
4497120600	Sensor forlengningskabel 6,0 mtr
4497120640	Sensor forlengningskabel 6,35 mtr
4497120700	Sensor forlengningskabel 7,00 mtr
4497120800	Sensor forlengningskabel 8,00 mtr
4497120900	Sensor forlengningskabel 9,00 mtr
4497121000	Sensor forlengningskabel 10,0 mtr
4497121200	Sensor forlengningskabel 12.0 mtr
4497200500	Folengelseskabel 5 Meter Slitasjevarsler
4497230230	Ebs E kabel for ABS
4497230300	Sensor forlengningskabel 3,0 mtr
4497230400	Ebs E kabel
4497231000	EBS E kabel 10 mtr for ABS sensor
4497520300	EBS kabel akselsensor EBS D 3.0mtr
4497520800	EBS kabel akselsensor EBS D 8.0mtr
4497521000	EBS kabel akselsensor EBS D 10.0mtr
4497620800	Kabel EBS E med kontakt 8.0mtr
4498030220	Kabel med kontakt
4498110500	Kabel nivå sensor EBS E
4498120300	Trykksensorkabel EBS E 3.0mtr
4498121000	Trykksensorkabel EBS E 10.0mtr
4498152530	Tilkoblingskabel EBS E 2x6.0mtr 4 pin
4498152580	Tilkoblingskabel EBS E15/6.0mtr 4 pin
4498160300	Kabel slitasjevarsling EBS-E 1.3mtr 6xplugg
4498340130	Kabel Ebs Modulator Til Kalipper
4499060600	Kabel EBS E2 ELEX Smartboard 6.0mtr 8 pin
4499080600	Kabel EBS E2 ELEX 6.0mtr 8 pin
4499110600	Kabel SmartBoard EBS E 6.0mtr 8 pin
4499130500	Tilkoblingskabel EBS E 5.0mtr 8 pin
4499140100	Tilkoblingskabel EBS E Telematic 1.0mtr 8 pin
4499150100	Tilkoblingskabel EBS E Telematic 1.0mtr 4 pin
4499151200	Tilkoblingskabel EBS E Telematic 12.0mtr 4 pin
4499162530	Tilkoblingskabel EBS E IVTM + smartboard 2x6.0mtr 8 pin
8946011322	Adapter/overgang fra bajonet til gjenger 0.15mtr kont.24mm
8946011332	Adapter/overgang ventil-kostal 0.15mtr kont.24mm
8946011342	Adapter/overgang fra bajonet til gjenger 0.15mtr kont.27mm
8946011352	Adapter/overgang ventil-kostal 0.15mtr kont.27mm
8946011382	Kabel
8946011422	Forsyningsledning

4491721200



4491731200



4492721200



4492731200



4493500100



4493720000



4494720800



4496720600



4497200500



4497230200



4498340130



4497120800



Wabco Actuatorer

Membransylindere 423

Membransylindere 423

Material (no)	Material korttekst
4230070190	Membrasylander Typ 30 Styr.Stab
4230089160	Membransylinder 36
4230089190	Membransylinder 36
4230200000	Membransylinder 3
4230200170	Membransylinder
4231029000	Membransylinder 9
4231039000	Membransylinder 12
4231046060	Brems Kammer Cam 16
4231049000	Membransylinder 16
4231050300	Brems Kammer cam 20
4231059000	Membransylinder 20 uten gaffel
4231062010	Brems Kammer Cam 24
4231069000	Membransyl Typ 24
4231073504	Spennbånd 30 Hol
4231079000	Membransylinder 30
4231097000	Brems Kammer Disc 27
4231097010	Brems Kammer Disc 27
4231127100	Membransylinder 18/Skivebrems
4231099000	Membransylinder
4232051000	Membransylinder 20
4232051010	Membransylinder 20
4454100400	30" Membr.styrb. [4231090190] Gl. stang

4231062010
4230040190

4232051000

4230089160

4230200000

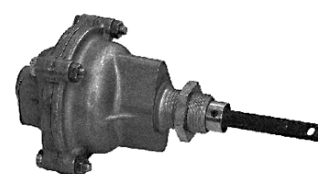

4231029000



Fjærsylinder cam 925

Fjærsylinder Cam 425

Material (no)	Material korttekst
9253222050	Fjærbrems
9253231307	Universal Fjær-Sylinder Cam F-36/30
9253250022	Rep Sett
9254300367	Tristop Cylinder Cam G-20/24 F
9254310082	Rep Sett
9254310947	Tristop-Cylinder Cam G-24/24 F
9254310957	Fjærbrems 24/24 Universal
9254311007	Fjærbrems 24/24
9254315147	Fjærbrems 24/30 Universal
9254316242	Stempelstang 24 For 925431....
9254322000	Universal Fjær Sylinder
9254323007	Fjærbrems
9254326512	Frontlokk 30 For Fjærbrems 9254
9254901050	Fjærbrems 20/24
9254911070	Tristop-Cylinder Cam G-24/24
9254911147	Fjærbrems
9254911417	Universal Fjær-Sylinder
9254922010	Tristop-Cylinder Cam G-30/24

9254215430



9254301000
9253222050



9254311007
9254901000



9254682510

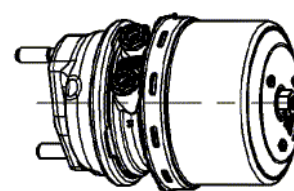

Fjærbrems kile

Fjærbrems kile

Material (no)	Material korttekst
4253332000	Tristoppsylinder 20/24
4253332120	Fjærbrems
4253330012	Rep Sett
4253360010	Fjærbremsklokke 24x60

Fjærsylinder Skive

Fjærsylinder Skive

Material (no)	Material korttekst
9254262010	Fjær Sylinder Disc G-14/16 HHD
9254600320	Fjærbremms
9254610320	Fjær-Sylinder Disc 24/24 universal
9254635010	Fjærbremms 18/24 Skivebremms
9254644510	Fjærbremms 16/16
9254644527	Fjær Sylinder Disc G-16/16
9254682510	Fjær Sylinder Disc G-14/16
9254810032	Rep.sett
9254810327	Fjærbremmsylinder til skivebremms
9254810507	Tristop Cylinder Type 24/24
9254810517	Tristop Cylinder Type 24/24
9254810700	Tristop Cylinder Type 24/30
9254812300	Tristop-Cylinder
9254812600	Tristop Actuator with IBV G-ty
9254813130	Tristop Cylinder 24/30
9254840220	Skivebremms 16/24 IBV
9254840230	Skivebremms 16/24 IBV
9254860110	Fjær-Sylinder Disc G-12/24
9254880140	Fjær-Sylinder Disc G-14/24

9254262010



9254682510

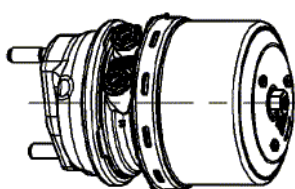

9254682530



9254812600

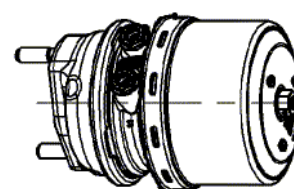

9254860110

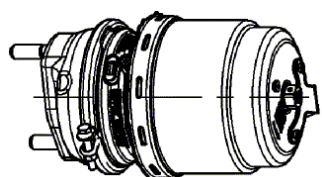

Bremseklokke dobbeltmembran trommel

Bremseklokke dobbeltmembran

Material (no)	Material korttekst
9253751000	Bremseklokke dobbeltmembran 20/30
9253761000	Fjærbrems 24/30
9253771240	Fjærbrems 30/30 76mm Slag m/ gaffelsats erst.1060
9253761240	Fjærbrems 24/30 75mm slag m/gaffelsats erst.1060

9253760000



9253761240



9253771000



1

Fjærbrems Double Diaphragm skivebrems

Fjærbrems Double Diaphragm

Material (no)	Material korttekst
9253840160	Bremsesylinder 16/24 skivebrems erstatter 4006064990
9253801040	Bremsesylinder 20/24 skivebrems erstatter 4006065000

9253840160



Tilbehør

Tilbehør

Material (no)	Material korttekst
4230005342	Gaffelsett
4230005352	Gaffelsett for membr.syl. langlock
4231063504	Spennring 24 Hol
4231073504	Spennbånd 30 Hol
4239025332	Gaffelsett for 12og16" bremseklokke
9253800502	Rørforlengersett til bremsesynder 9253801010
9253840502	Rørforlengersett til bremsesynder 9253840100

4230005352



4239025332



9253840502

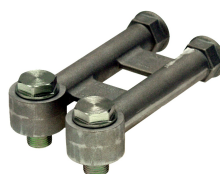

Membraner

Membraner

Material (no)	Material korttekst
8971205504	Diaphragm 55
8971205054	Membran 12
76.405-10	Membran 16 8971205104
76.413-10	Membran 16 langslag 8971205164
76.406-10	Membran 20 8971205204
76.414-10	Membran 20 langslag 8971205264
76.407-10	Membran 24 8971205304
8971205354	Membran 24 Langslag
76.415-10	Membran 24 langslag 8971205364
8971205474	Membran 27 Hol
76.408-10	Membran 30 8971205404
76.416-10	Membran 30 langslag 8971205464
76.409-10	Membran 36 8971205504

8971204954

1



Spring brake Actuator

Spring brake Actuator

Material (no)	Material korttekst
4253110002	Rep sett for 425 311 004 0 / 005 0
4253110047	Sperresylinder 65Øx50 Slag

4253110047



Kontrollenheter luftfjæring

Nivåventiler

Nivåventiler

Material (no)	Material korttekst
4640027302	Arm For Nivåregulator Luftfj.
4640060000	Nivåreguleringsventil
4640060002	Rep sett til 464 006 000-007.0
4640060007	Nivåreguleringsventil
4640060127	Nivåreguleringsventil tolinjersport M12X1
4640061010	Nivåregulator med høydebegrensning sort
4640067302	Stang for nivåventil
4640070020	LuftFjæringsventil M10X1
4640070100	Levelling Valve

4640061000

4640070100

4640027302

4640060007

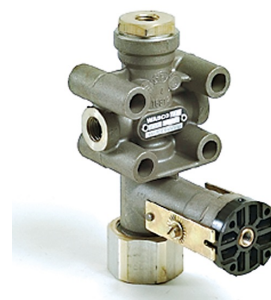

4640061007

4640060127

4640070010

4640070100

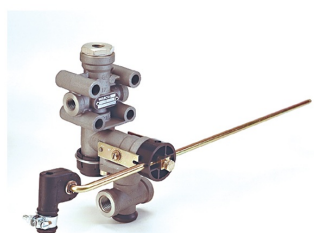

4640080070



Hev / senkventiler

Hev senkventil roterende

Material (no)	Material korttekst
4630320207	Hev/Senkventil Port1: M16X1,5
4630320200	Hev/Senkventil Port1: M16X1,5
338021001	Hev/Senk Ventil 4630320200

4630320207

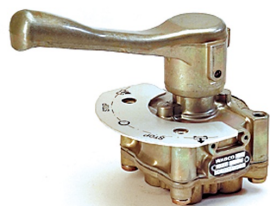

TASC 463090

TASC 463 090

Material (no)	Material korttekst
4630905000	TASC Ventil port 12x1.5mm push in
4630905020	TASC Ventil port 16x1,5mm
4630900230	TASC Ventil port 12x1.5mm, 16x1.5mm

4630905000



4630900230



Løfteaksventil

Løfteaksventil

Material (no)	Material korttekst
4630840000	Løfteaksventil manuell Port 41: Reservoir 463 084 020 2 Erst.4630840010
4630840100	Løfteaksventil elektrisk Port 41: Reservoir 463 084 020 2 Erst.4630840110
4630840200	Løfteaksventil helautomatisk Port 41: Reservoar 463 084 020 2
4630840202	Reservoar til 4630840200
4630840310	Løfteaksventil enkeltkrets DIN 72585-A1-3.6-Sn/K1
4630840410	Løfteaksventil enkeltkrets push in 8.0x1.0mm DIN 72585-A1-3.6-Sn/K1

4630840000

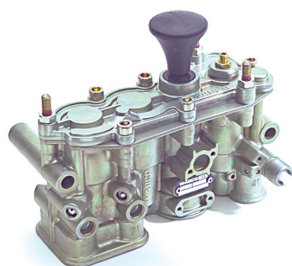

4630840100

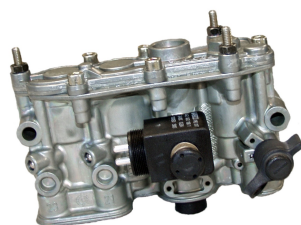

4630840200

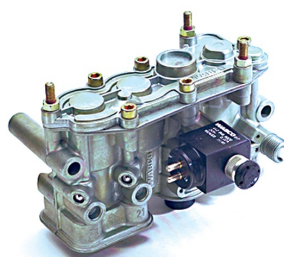

4630840310



4630840410



Elektronisk kontroll av luftfjæring

ECAS

ECAS

Material (no)	Material korttekst
4460550650	Ecas Elektronikk Trailer Ra Fa La VCS I
4460550660	Ecas Elektronikk Trailer Ra Fa La EBS / VCS II
4460553010	Ecas Elektronikk Truck Ra Fa MAN
4460553120	ECU ECAS Truck 4x2 Ratio Ra Fa Diagn. DAF
4460554060	ECU, ECAS Truck 6x2 Ra Fa La Scania
4460555010	ECU ECAS Bus Ra Fa
4460555202	Ecas monteringssett for 446 055 060 0 / 070 0
4461200000	Ecas Strømforsyning/Kompakt 1M
4461200140	Ecas/Vcs sett
4461200200	Eca/Ebs Sett Tilhenger
4461200230	Eca/Ebs sett tilhenger Fa Ra kontroll La
4741000010	ELM elektronisk luftfjær modul for henger

1

4460550650



4460550660

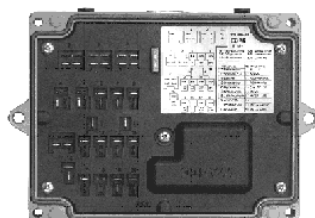

4460553010



4460554060



4741000010



ECAS fjernkontrollenheter

ECAS Fjernkontroll

Material (no)	Material korttekst
4460560104	Ecas Festeclip
4460560524	Ecas Holdeblekk
4460561160	Ecas Betjeningsenhet
4460561170	Ecas Betjeningsenhet
4460561190	Kontroll panel, ECAS
4460561380	Kontroll panel, ECAS
4460561390	Kontroll panel, ECAS
4460561460	Control panel, ECAS
4460562500	ECAS Kontroll Enhet
4460563330	ECAS kontroll enhet
4461560000	ECAS Kontroll Boks
4461560110	ECAS Kontroll Boks
4461560120	ECAS Kontroll Boks
4461560210	ECAS Kontroll Boks

4460560000

4460560104

4460560524

4460561160

1

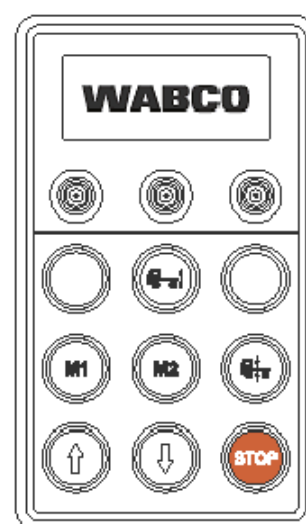
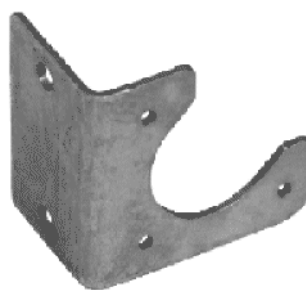

4460562500

4461560100



ECAS Magnetventiler

ECAS Magnetventiler

Material (no)	Material korttekst
4728800010	Magnet Ventil
4728800040	Solenoid Valve
4728800300	Magnet Ventil
4728800320	Solenoid Valve
4729000010	Ecas Magnetventil
4729000080	Ecas Magnetventil 2 H-Sens Bak
4729000120	Ecas Magnetventil
4729000130	Ecas Magnetventil Bak/Foran
4729000137	Ecas Magnetventil
4729000210	Ecas Magnetventil
4729000300	Ecas Magnetventil
4729000320	Ecas Magnetventil
4729000500	Magnetventil
4729000507	Magnet Ventil
4729000550	Ecas Magnetventil 1 H-Sens Bak
4729000580	Ecas Magnetventil 1H-Sens Foran
4729000600	Magnet Ventil
4729001120	Solenoid Valve
4729009212	Rep Sett
4729009232	Rep Sett
4729050042	Rep Sett
4729050700	Magnet Ventil
4729051080	Ecas Magnetventil 2H-Sens Bak Løft
4729051090	Ecas Magnetventil
4729051110	Magnet Ventil
4729051140	Ecas Magnetventil

4728800300

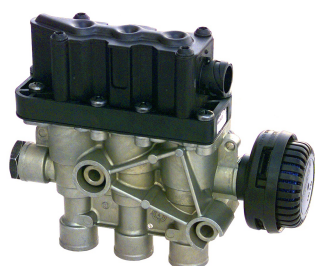

4729000010

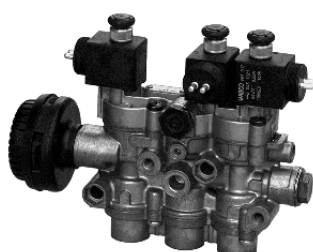

4729000020

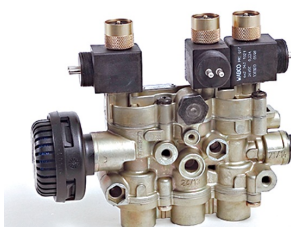

4729000210

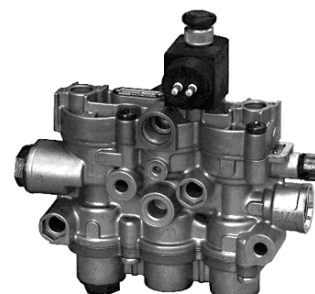

Trykkluftutstyr

4729000300

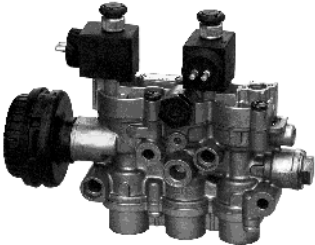

4729000500

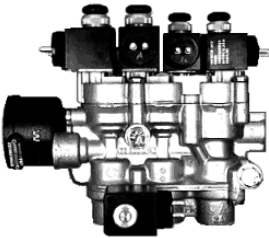

4729000550

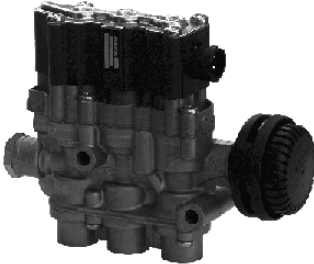

4729051080

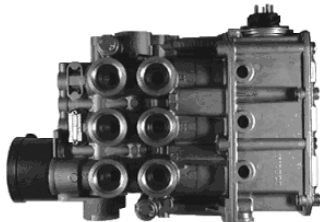

4729051140



1

ECAS Nivåsensorer

ECAS Nivåsensorer

Material (no)	Material korttekst
4334010030	Lenkesett F. Nivåreg. 464....
4334010040	Lenkesett F. 80661
4334013804	Endestykke For Nivå
4410500060	Ecas Nivåsensor Bajonett
4410500080	Ecas sensor M24X1 u/hendel
4410500100	Ecas Sensor Nfz
4410500110	Ecas Nivåventil Din-Bayonett
4410500120	Avstand sensor
4410501000	Avstand sensor
4410507182	Arm
8975301604	Gummioppheng Alb Mek.Fjær.4334010040

4334010030



4334010040



4334013804

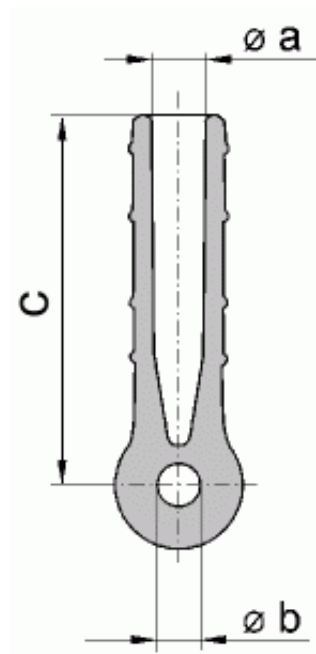

4410500060 / 080



4410501000



4410507182



Kabel til luftfjæring

Kabel til luftfjæring

Material (no)	Material korttekst
4493360300	Strømforsyningskabel 3mtr VCS II T ECAS diagnose 6 pin
4493373280	Strømforsyningskabel 3/12mtr VCS II T ECAS diagnose 6 pin
4493401530	ELM kabel + diagnose
4493480200	EBS kabel henger 2.0mtr. 4 pin
4493542530	Diagnosekabel 6/6mtr VCS I Elm
4496201560	diagnose+slitasjevarsler+modulatorkabel
4496210600	Diagnose Kabel
4496320500	Ecas Betjeningskabel
4496320800	Kabel Betjeningsenhet
4496330600	Kabel Fjærnk kontroll 6.0M Elm
4496370500	Kabel med Kontakt
4496380600	Kabel med Kontakt
4497320600	Kabel med Kontakt
4497420500	Ecas Kabel
4497420600	Kabel med Kontakt
8946010382	Kabel
8946042152	Kabel Ecas,Ebs,Akselløftventil

1

4493360300



4493480200



4496320500

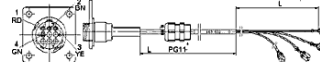

4496320800

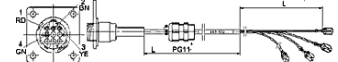

4496350500



4497420500

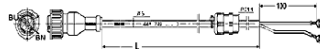

4497421500



TCE 446 122

TCE 446 122

Material (no)	Material korttekst
4461224010	Ultrasonic sensor LIN EBS E2 0 grader
4461224020	Ultrasonic sensor LIN EBS E2 15 grader
4461220530	Wabco CAN-repeater

4461224010



4461220530



Trailer connection

Koblingshoder

Koblingshoder

Material (no)	Material korttekst
4522000000	Hanske Kobling
4522000110	Koblingshode M22X1,5 F/Toleder Rød
4522000120	Koblingshode M22X1,5 F/Toleder Gul
4522002110	Koblingshode M22X1,5 M/Ventil Rød
4522002120	Koblingshode M22X1,5 M/Ventil Gul
4522006572	Deksel
4522010100	Kobbling store ører
9522000220	koblingshode M16X1,5 F/Toleder Gul
9522000210	Koblingshode M16X1,5 F/Toleder Rød
9522002220	Koblingshode M16X1,5 M/Ventil Gul
9522002210	Koblingshode M16X1,5 M/Ventil Rød
9522009020	Hanske Kobling
9522010140	Luftkobling
9522010150	Luftkobling

1

4522000000



4522000110

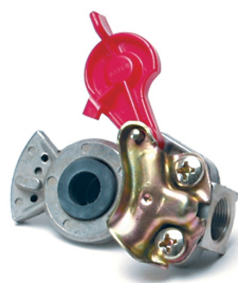

4522002110



4522002120



4522010100

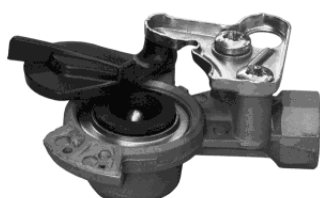

9522000210

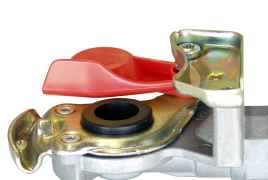

9522000220



9522000220_1



9522002210



9522010140



9522010150



Ledningsfilter

Ledningsfilter

Material (no)	Material korttekst
4325000200	Ledningsfilter. M22 X 1,5

1

4325000200



Duomatic 452 800

Duomatic 452 800

Material (no)	Material korttekst
4528020032	Rep sett Duo Matic 452 802 / 805
4528020070	Duo-Matic bildel M16X1,5
4528020090	Duo-Matic bildel M16X1,5 Witht homologation (Tysk ABE)
4528021004	Festeplate Duo-Matic
4528026904	Aksel
4528030040	Duomatic semtrailer hengerdel 16x1.5mm
4528030050	Duomatic semtrailer hengerdel 16x1.5mm festeplate 4528021004
4528040120	Duo-Matic henger 16x1,5mm
4528050040	Duo-Matic Semtra 16x1,5mm

4528020070



4528020090
4528030050
4528030040



4528040120
4528050040



Spiralkabel 446....

Spiralkabel 446 ...

Material (no)	Material korttekst
4460082430	ABS/EBS spiralkabel maks lengde 4,5m, Ø spiral=110 mm
4460083104	Abs kontaktstift 1,5 mm
4460083114	Abs kontaktstift 6 mm
4460083154	Abs kontakthylse 1,5 mm
4460083164	Abs kontakthylse 6 mm
4460083802	Abs kontakt for bil
4460083902	Abs støpsel for henger
4460084042	EBS kontakt for bil krymp
4460084142	EBS støpsel krymp for henger
4460084332	EBS kontakt 7-pol 24V ISO 7638 skru
4460086002	ABS/EBS støpselholder
4460087000	ABS/EBS spiralkabel maks lengde 4,0m, Ø spiral=53 mm
4460087100	Spiralkabel 15-pol
4460089022	Matrise Til Verktøy
4460089042	Matrise Til Verktøy

1

4460082430



4460083104

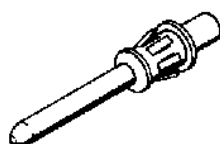

4460083154

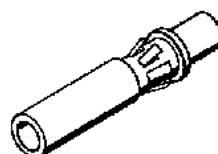

4460083802



4460083902



4460087000



4460087100



4460089022

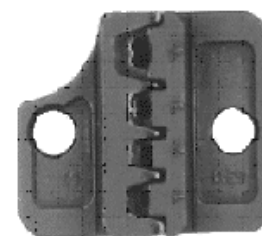

Drive Line Control

Mastersylinder

Mastersylinder

Material (no)	Material korttekst
9740100010	Servo Master

9740100010

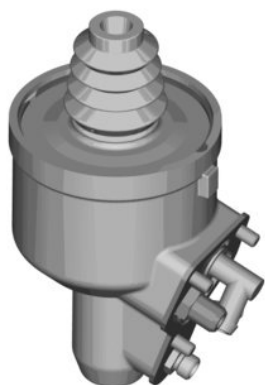

Clutch Servo

Clutch Servo

Material (no)	Material korttekst
9700519032	Rep sett for 9700511310
9700519862	Rep sett for 9700514... .
9700511317	Clutch servo bytteenhet for 970 051 131 0
9700511920	Clutch servo DAF Volvo FM7, FM10, FM12 F12 FL12 FH12, FH16 NL10, NL12 B7, B10, B12

9700511317



1

Elektronisk Drive Line Control

Electronic Drive Line Control

Material (no)	Material korttekst
4213520820	Gearbox actuator
4213559312	Rep sett ZF girka Pressure Limiting Valve, ZF Astronic 421 355 011/ 012/ 014/ 022/ 023 0
4411005312	Avstand sensor Modul
9701500010	Clutch actuator EPSIII Actros MP2

4213520820

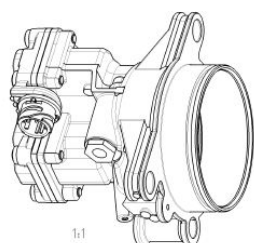

4213559312

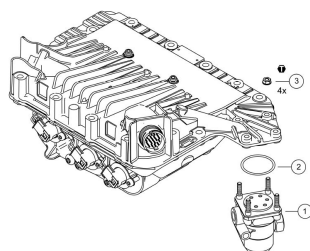

4411005312

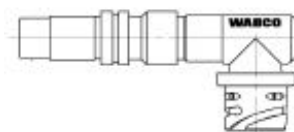

9701500010

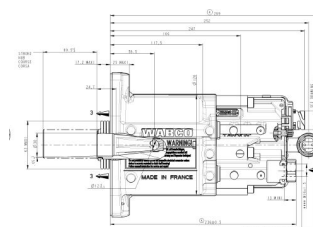

Retarder Control

Retarder Control

Material (no)	Material korttekst
4722600050	Ventil

4722600050

4722600050



Utstyr til busser Climate Control

Climate Control

Material (no)	Material korttekst
4460910040	Ventil Enhet EVO
4460920030	Temperatur Sensor
4460950030	Elektronikk
4460950070	ECU Panel Kontroll

4460950030



4460950070

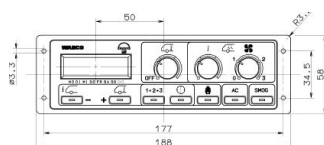

4460910040



4460920030



Elektronisk dørkontroll enheter

Elektronisk dørkontroll

Material (no)	Material korttekst
372060002	Rep sett for 372060022/062/082- 4726000220
422802002	Rep sett for 422802300-311 0
4228120000	Dørsylinder Ø 50mm Slag 140mm 14x1,5mm maks 10 bar
4228120002	Rep sett for 422812000/0020
4461901520	Dør sensor Actuating range electrical 125° ±3°
4720170002	Rep sett for 472017480 / 4810
4720174800	4/2-Veis Dørventil 24V Ns
4726000220	Dør kontroll ventil 4/3, 12x1.5mm 5-10 bar

4461901520



4720174800



4726000220

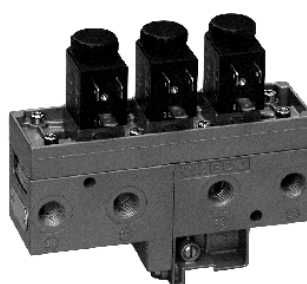

42281220000

MTS door cylinder



Enheter for universelt bruk

Arbeidssylinder

Arbeidssylindere

Material (no)	Material korttekst
4210210300	Stempelsylinder 65Øx
4214100012	Rep sett for 421410012-039 0
4214100257	Sylinder 300X25 Slag
4214100410	Arbeidssylinder 30Øx45 Slag
4214100540	Arbeidssylinder Ø30X45 Akselløft/LuftFjæring
4214100590	Arbeidssylinder 30Øx30 Slag
4214110310	Arbeidssylinder 35Øx
4214113010	Arbeidssylinder 35Øx78 Slag
4214113140	Sylinder
4214250022	Rep sett for 421425010 / 011 0
4214250100	Sylinder 25Øx48 Slag
4214250110	Arbeidssylinder 25Øx
4214290020	Arbeidssylinder 28Øx70 Slag

1

4214100250



4214100410



4214100540
4214110270



4214100590



4214110210



4214110310



4214250100



4214450000



Tilkoblingskabel

Tilkoblingskabler

Material (no)	Material korttekst
4494150800	Kabel for magnetventil 8.0mtr rett bajonett
4495150200	Kabel med kontakt 90 grader 2 mtr
8946004502	Kabel med plugg 24x1mm til solenoid ventil
8946004512	Kabel 0.3mtr 27x1mm 90 grader plugg
8946004542	Kabel med plugg 27x1mm 5mtr erstatter 8946004532
8946011322	Adapter/overgang fra bajonet til gjenger 0.15mtr kont.24mm
8946011332	Adapter/overgang ventil-kostal 0.15mtr kont.24mm
8946011342	Adapter/overgang fra bajonet til gjenger 0.15mtr kont.27mm
8946011352	Adapter/overgang ventil-kostal 0.15mtr kont.27mm

4494150800

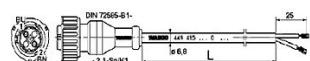

4495150200



894600



8946011322



8946011342



8946011352

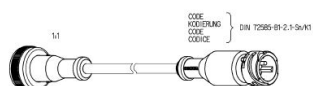

Støydempere / eksosventiler

Støydempere

Material (no)	Material korttekst
4324070600	Støydemper M22X1,5 Max 30Bar
4324070700	Lyddemper/Filter 11Bar snap on
4327000000	Filter Eksos M22X1,5
4327030000	Exhaust Filter
5324000020	Lyddemper
5324001110	Silencer
5324001120	Silencer
8994702802	Exhaust

4324070700



4324070600



4327000000



4327030000



To-veis ventiler

To-veisventiler

Material (no)	Material korttekst
4342020012	Rep sett for 4342021000
4342021000	2-veisventil M22X1,5 Nw 7Mm
4342050210	Sperreventil M/Knapp M14X1,5
4342050260	Sperreventil U/Knapp M14X1,5
4342050300	3/2 Direkte Kontroll Ventil
4342080210	To-Veisventil M22
4342080290	2-VEISVENTIL M22
4342080550	To-veis ventil
5340170000	Dobbel Kontroll Ventil
5340170100	Dobbel Kontroll Ventil

4342021000

4342050260

4342080290

4342080200



4342080290

4342080500

4342080550

5340170000



Tre-veis ventiler

Tre-veisventiler

Material (no)	Material korttekst
4342050260	Sperreventil U/Knapp M14X1,5
4630131160	3/2 Ventil
4630360000	3/2 Direkte Kontroll Ventil
4630360160	3/2 Direkte Kontroll Ventil
4630371020	4/3 Direkte Kontroll Ventil
5630201010	3/2 Direkte Kontroll Ventil NW4
5710400000	3/2 Direkte Kontroll Ventil
5772020002	Rep Sett For 571040....
9640010020	Rangventil Sperreventil Max 12Bar

4342050260



4630131160



4630360000



5630200000

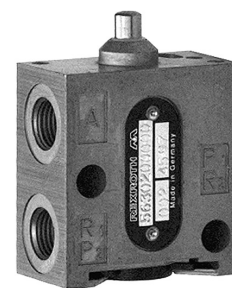

5710400000

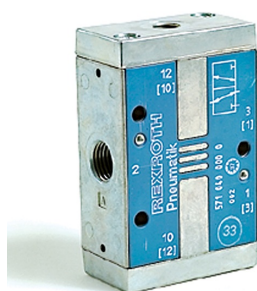

9640010027



Magnetventiler



Magnetventiler

Material (no)	Material korttekst
4720726280	Ventil
4721020407	3/2-Veis Magnetventil N4V Nå
4721271407	Magnetventil 12/24V Ns M12X1,5 1P68
4721700414	Kappe
4721706060	3/2 Magnet Ventil NS 24 V
4721717260	Magnetventil 24V Nå Din-Bayonett
4721726000	Magnetventil
4721726260	Magnetventil 24V Ns Din-Bayonett
4721727260	3/2 Magnet Ventil
4721732060	3/2 Magnet Ventil
4721737040	3/2 Magnet Ventil

1

4720726280



4721020407



4721271407



4721717260



Tilbakeslagsventiler

Tilbakeslagsventiler

Material (no)	Material korttekst
4340140000	Tilbakeslagsventil M22X1,5 20Bar
4340140210	Tilbakeslagsventil M22X1,5 20Bar
4340150000	Tilbakeslagsventil M22X1,5
4340150002	Rep sett for 4340150000/010-013 0
4340210000	Backventil M22X1,5

4340140000

4340140210

4340150000

4340210000



Trykkbrytere

Trykkbrytere

Material (no)	Material korttekst
4410091010	Trykkbryter 22X1,5 U 5+0,2
4410140010	Bryter M12X1,5 2+-0,2Bar
4410140040	Bryter 5,5Kg+-0,6Kg.Aus
4410140050	Bryter M10X1 2,0 I
4410140060	Bryter M12X1,5 2,0 U
4410140090	Bryter M10X1 4,0 I
4410140100	Bryter M12X1,5 0,3 U
4410140120	Bryter M12X1,5 3,5 U
4410140130	BRYTER
4410140140	Bryter M12X1,5 4,5 U
4410140150	Bryter M12X1,5 5,0 U
4410140170	Bryter M12X1,5 4,0 I
4410140200	Trykk Bryter
4410140210	Bryter M12X1,5 0,5 I
4410140290	Trykk Bryter
4410400030	Ecas Trykksensor
4410441010	Trykksensor 16X1,5mm Din-Bayonett erstatter 441 040 007 0 / 010 0
4410441020	Trykksensor 16X1,5mm Din-Bayonett erstatter 441 040 015 0 / 002 0
4410441080	Trykksensor 16X1,5mm Din-Bayonett

4410140010



4410140060

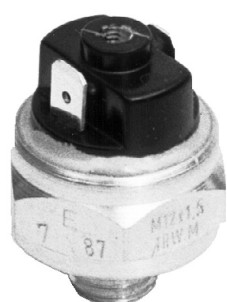

4410400030



4410441010



Bremseslange

Bremseslange

Material (no)	Material korttekst
8288760116	Bremseslange 11x3.5 20M rull
8288764116	Hanske DIN74310-11x3,5/Roll - 40m

Diverse

Diverse

Material (no)	Material korttekst
8305020764	Wabco Fett 5G
8305030654	Wabco Speisalfett 1000 Gram.
4345000030	Sperreventil M22X1,5 (selectlow)
4530020000	Manometer 60Ø

8305030654



8305020764



4345000030



4530020000



Knorr trykkluftutstyr ABS Modulator henger



ABS Modul henger

Material (no)	Material korttekst
K004246	Modulator ABS KB4TA ES1305.

K004246



1

ABS Modulator ventil

ABS Modulator ventil

Material (no)	Material korttekst
K015677N00	ABS modulator ventil med kabel BR9154
II17776N00	Trykkstyringsventil
II16278	ABS ventil BR9152

K015677N00



II16278



II17776N00



ALB ventil

ALB Luftfjærventil

Material (no)	Material korttekst
I136836	ALB ventil luftfj. BR5522
SEB00933	ALB - Ventil for bladfjæring BR4370
SEB01315	Gaffelsett bremseklokke

I136836



SEB00933

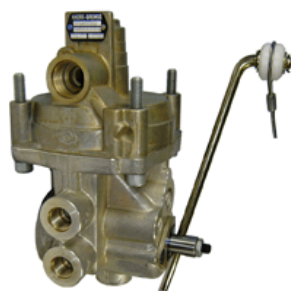

EBS Modulator Bil

EBS Modulator bil

Material (no)	Material korttekst
ES2053	EBS modulator alt.art. 1139782N50
I139782N50	EBS modulator TEBS
I139797F	Etikett EBS
K020024N50	EBS to-kanals mod . MAN

I139782N50



K020024N50



EBS Modulator Henger

EBS Modulator henger

Material (no)	Material korttekst
K019312V04N00	EBS modulator TEBS G2.1 ES2060 U/nipler
K019319V04N50	EBS modulator TEBS G2.1 ES2060 M/nipler
K020023N50	EBS to-kanals modulator
K021940V01N00	EBS modulator ES2070
K027900V00N00	EBS modulator EMP TEBS G2 ES2071
K021203N50	EBS modulator 1 kanals
K021202N50	EBS E en kanal modul

K021940V01N00



K019319V04N50



K027900V00N00

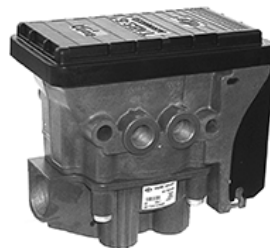

K020023N50



K021203N50



K021202N50



Kompressor ensylindret

Kompressor ensylindret

Material (no)	Material korttekst	Best.vare
K004641X00	Kompressor 359cc Type LP3970	x

K004641x00



Lufttørke

Lufttørker

Material (no)	Material korttekst
II30448	Lufttørke m/varme 8,1 bar LA8234
SK2767/5	Rep.sett for tørke
II19207	Lufttørker 10.0 bar m/varme, LA8210
II39752F00	Lufttørker 12.0 bar m/varme, type LA8286
II39751F00	Lufttørker 8.5 bar m/varme, LA8271
0501100407100	Elektronisk lufttørker
1507434000000	Patron for lufttørker

SK2767/5



II19207



II39752F00
II39751F00
II30448

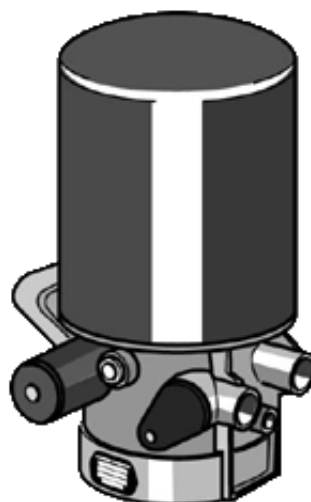

0501100407100



1507434000000



Magnetreleventil

1

Magnetreleventil

Material (no)	Material korttekst
II37091N00	Modulator bajonett BR9234
II32614	Modulator M24 BR9232
II30522	Modulator M24 dobbel BR9231

II37091N00

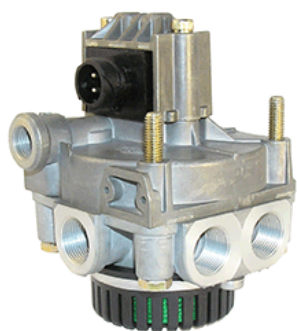

II32614



II30522

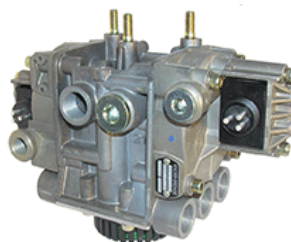

Firekretsventil

Firekretsventiler

Material (no)	Material korttekst
II37680N50	Firekretsventil AE4510
II36012000	Firekretsventil AE4604
K000516	Firekretsventil AE4625
II15588000	Beskyttelsesventil 4-krets AE4428
II36011000	Firekretsventil AE4603
II38801F	Beskyttelsesventil 4-krets

II36012000



II37680N50



II15588000



K000516



II36011000



II38801F



Hev/Senk ventil

Hev / senk ventiler

Material (no)	Material korttekst
K002018	Hev / senk ventil SV3240
I83153	Hev / senk ventil SV3111
SV3111	Hev / senk ventil bruk I83153
K054887N00	Hev / senk ventil m / RTR SV3
I136167008	Rep sett for I136205/SV3293 og I136227/ SV3272

k002018



I83153

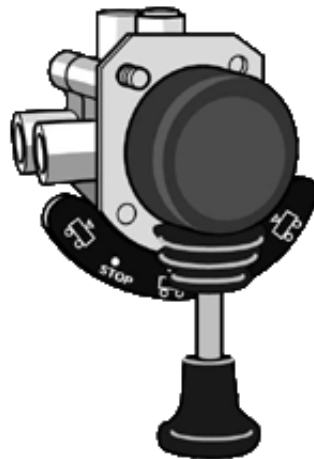

K054887N00



Ventil

Ventil

Material (no)	Material korttekst
I61236	Trykkbegrensningsventil, type DB1103

I61236



1

Rep sett calipper

Rep sett Calipper

Material (no)	Material korttekst
K010604	Rep sett Calipper

K010604



Ventilblokk

Ventilblokk

Material (no)	Material korttekst
0501100029000	ELC ventilblokk
0501100041100	ELC ventilblokk

0501100029000



0501100041100

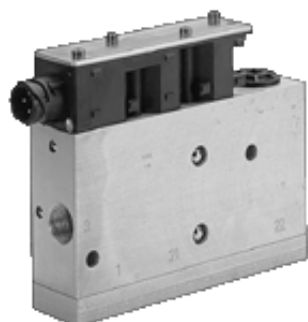

Kombiløseventil

Kombiløseventil

Material (no)	Material korttekst
K025700N00	Kombiløseventil m/ overstr.vent. AE4370
K025699N00	Kombiløseventil m/ overstr.vent. AE4371
AE4311	Dobbel løseventil K015849N00
K015849N00	Kombiløseventil u/overstr.ventil AE4311
K015380N00	Kombiløseventil m/overstr.ventil AE4311
II36128	Kombiløseventil AE4230
II36131	Rangeringsventil AE4247

K025699N00

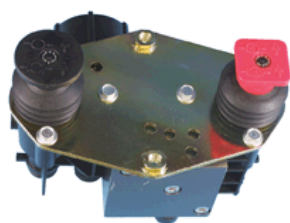

K025700N00



K015380N00



K015849N00



II36128



II36131



Løfteaksventil

Løfteaksventil

Material (no)	Material korttekst
K035570N00	Løfteaksventil Alternativ AE1141
K008546	Løfteaksventil Alternativ AE1141 / K035570N00
K015384	Løfteaksventil AE1141
K017224N00	Løfteaksventil luftstyrt AE1141

K035570N00



K008546

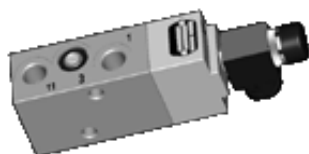

K015384N00



K017224N00



1

Nivåsensor

Nivåsensor

Material (no)	Material korttekst
K013741N00	Nivåsensor

K013741N00



Trykkregulator

Trykkregulator

Material (no)	Material korttekst
K000644	Trykkregulator DR4378

K000644



Fjærbrems

Fjærbrems

Material (no)	Material korttekst
K031739N00	Fjærbrems T24 Type nr. BX7523
K017119N00	Fjærbremssylinder til skivebrems T24 BS 8500
II17776N00	Trykkstyringsventil
K031744N00	Fjærbremssylinder T30, type BX7611
267086	Gaffel Scania 5/8
K2B0504SX	Fjærbrems T20 Scania
K2B0506SX	Fjærbrems T24 Scania
K2B0514SX	Fjærbrems T24 Volvo
K2B0521SX	Fjærbrems T30 Scania
K026903N00	Fjærbremssesyl. BS7751 Skivemrems 18/24
BS3326	Knorr Membr.syl. 16 Skive
BS3350	Membransylinder 16'/skivebrems

K031739N00



K017119N00

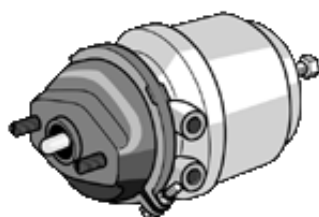

K2B0506SX



II17776N00



K031744N00



267086

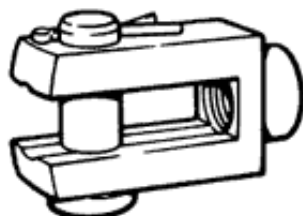

K2B0514SX



K2B0521SX



K2B0506SX



K026903N00



Tilkoblingskabel og kontakter

Kabel og kontakter

Material (no)	Material korttekst
K002281N00	Tilkoblingskabel
K027811N00	Tilkoblingskabel
K027813N00	Tilkoblingskabel
K002274N00	Tilkoblingskabel
K002276N00	Tilkoblingskabel
K058334N00	Tilkoblingskabel TEMP-S 9m
K002271	Diagnose kabel 6 mtr
K013194	Diagnose kabel 4mtr
K002276	Kabel for magnetventil TEBS 10 mtr
K002279	Kabel for modulator 4S/3M 9mtr
K002287N00	Kontakt for in /out TEBS G2
K002287	Kontakt for in-out
K002288	Strømtilførsel kabel TEBS 13mtr u/kont.
K002886	Strømtilførsel kabel TEBS 0,5mtr
K008431N00	Strømtilførsel kabel semi TEBS G2 13m
K022274N00	strømtilførsel kabel slep/kjerre
K016991	Strømtilførsel kabel m/diagn.for 4S/3M
K015468N00	strømtilførsel kabel uten kontakt
II367564000	Forlengelseskabel EK3130 4mtr
II3979312000	Forlengningskabel EK3115
EK3110	Forsyningskabel EBS II36741/12000
EK3108	Forsyningskabel EBS II40391F1
II3675610000	Forlengelseskabel EK3130 10mtr
II367568000	Forlengelseskabel EK3130 8mtr
II367565000	Forlengelseskabel EK3130 5mtr
K027814N00	Kabel til EMP 3 mtr
K022279N00	Kabel til EMP 6 mtr
K005378	Lokk for diagnose kabel
K002286N00	Strømforsyningskabel

K002281N00

K027811N00

K002271

K002276N00

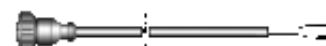

K002274N00



K002279



K002288



K008431N00



K016991

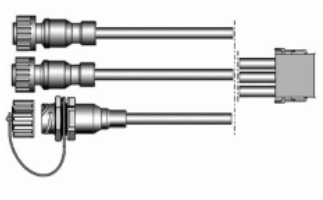

K027814N00



K022274N00



K002276



1

K002287N00

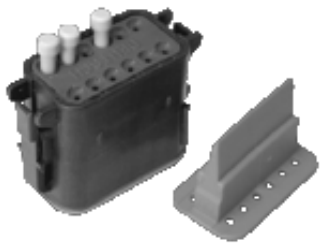

EK3110



EK3108



Tilhenger Bremseventil

Tilhenger Bremseventil

Material (no)	Material korttekst
AS3100A	Tilhengerbremseventil m/rang.
AS3000A	Tilhengerbremseventil u/rang.vent.

AS3000A



AS3100A

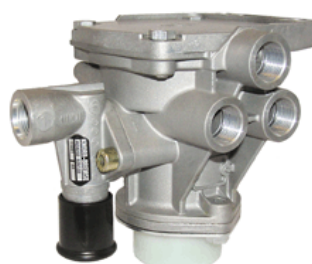

Releventil

Releventil

Material (no)	Material korttekst
AC574AXY	Releventil Daf, Iveco, Scania, Volvo
AC574A	Releventil Renault, Scania

AC574AXY



AC574A



Nivåventil

Nivåventil

Material (no)	Material korttekst
II36115	Nivåventil m/høydebegr. SV1466
K000367	Nivåventil m/høydebegr+2 kjhøyd. SV1485
II19425	Nivåventil type SV1395
II30525000	Nivåventil type SV1399
I85698	Ventil SV1295

II36115

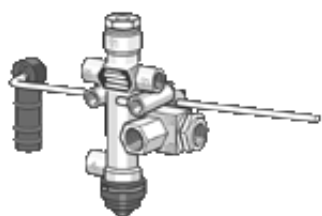

K000367



II19425



II30525000

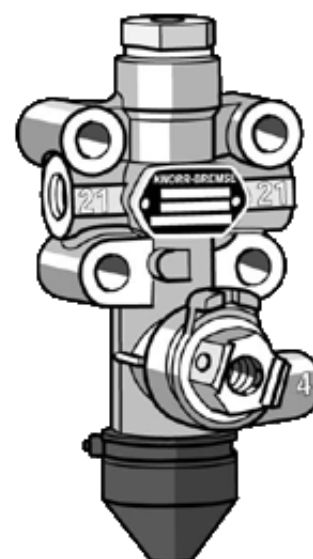

I85698



Overstrømsventil

Overstrømsventil

Material (no)	Material korttekst
K000636	Overstrømsventil just. 0-10 bar DR4370
K000647	Overstrømsventil 7.0 bar, type DR4381

K000636

K000647



Hurtigtløser

Hurtigtløser

Material (no)	Material korttekst
274998	Hurtigtløser
KX2552/3	Hurtigtløserventil
KX2000/1	Hurtigtløserventil M22 Daf, Man, Volvo

274998

KX2552/3

KX2000/1

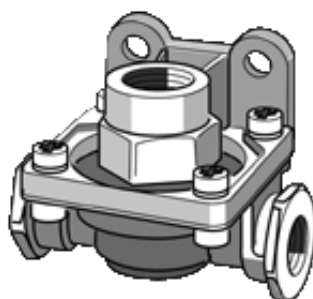
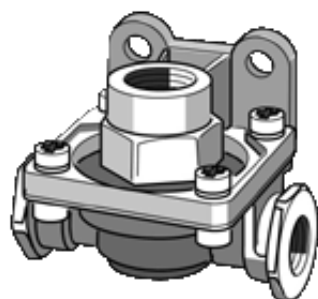

Rep sett skivebremser

Rep sett skivebremser

Material (no)	Material korttekst
K046771K50	Rep sett for skivebrems 22,5"
K001915	Rep sett for skivebrems 22,5" alt.nr. 3434381200
K035471K50	Bremsekloss-sett
K035472K50	Bremsekloss-sett
K046523K50	Tetningssett til Calipper

K046771K50



K001915



K035472K50
K035471K50



K046523K50

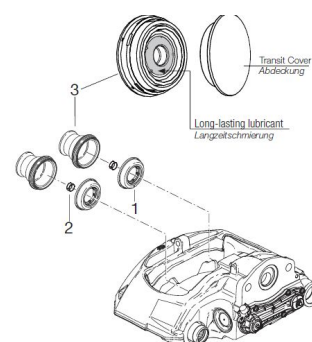

Sensorsett

Sensorsett

Material (no)	Material korttekst
486000136000	Sensorsett 1,0 mtr
486000134000	Sensorsett

486000136000



486000134000



Membransylinder

Membransylinder

Material (no)	Material korttekst
I133445A	Membransylinder T30, type BX3605
I133441A	Membransylinder T24, type BX3534

I133445A

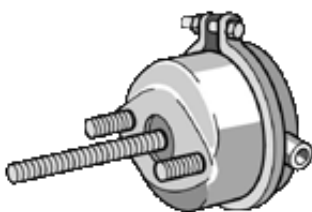

I133441A

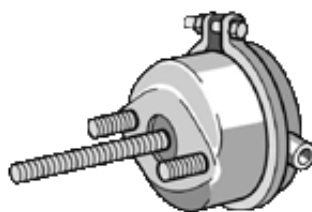

Koblingshode

Koblingshoder

Material (no)	Material korttekst
K000952	Luftkopling rød, type KU1400
K000954	Luftkopling gul, type KU1410
II17355	Luftkopling styreledning gul 16mm, type KU1311
II17354	Luftkopling mateledning rød 16mm, type Ku1310
II33262	Luftkopling, type KU1304

K000952

K000954

II17355
II17354

II33262

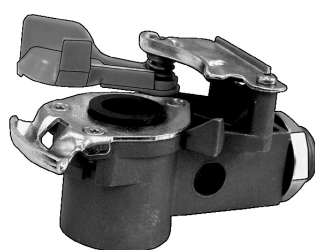
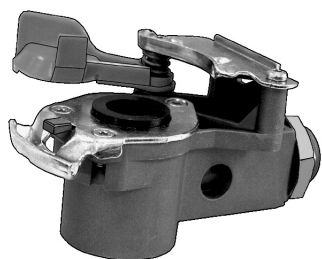

Fotbremsventil

Fotbremsventil

Material (no)	Material korttekst
DX80D	Fotbremsventil Iveco, Scania

DX80D



1

Justeringsverktøy

Justeringsverktøy

Material (no)	Material korttekst
K000029	Justeringsverktøy

Gummimembran

Gummimembran

Material (no)	Material korttekst
24LS	Gummimembran T24 57mm HUB langslag
30LS	Gummimembran T30 langslag

24LS

30LS



Ledningsfilter

1

Ledningsfilter

Material (no)	Material korttekst
199660	Ledningsfilter, LA2103

199660



Sperreventil

Sperreventil

Material (no)	Material korttekst
I133261	Sperreventil AE2110
I28323	Sperreventil AE2100 Kran

I28323

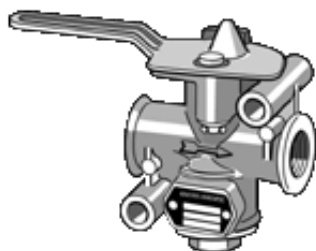

Sikkerhetsventil

1

Sikkerhetsventiler

Material (no)	Material korttekst
KX1729/1	Sikkerhetsventil, type AD-2

KX1729/1



Støydempere

Støydempere

Material (no)	Material korttekst
0484210002000	Støydemper M16

0484210002000



1

Kontroll enhet TRM

Kontroll enhet TRM

Material (no)	Material korttekst
K036198V02N00	Kontroll enhet TRM

K036198V02N00



Haldex

Lufttank

Lufttank

Material (no)	Material korttekst
030350209	Lufttank 10Ltr Ø206mm L370mm
030350909	Lufttank 30 Ltr Ø246mm L720mm
030360809	Lufttank 60 Ltr Ø310mm L895mm
030351609	Lufttank 60 Ltr Ø276mm L1110mm
030352009	Lufttank 80 Ltr Ø396mm L750mm

030350209

030350909

030360809

030351609



030352009



Membransylinder

Membransylinder

Material (no)	Material korttekst
123120002	Membransylinder T12 L=186mm
123200001	Membransylinder 20
123240001	Membransylinder 24
123300001	Membransylinder 30
125160001	Membransylinder 16
1351624004	Membransylinder (DDSB) 16/24
1352024003	Membransylinder (DDSB) 18/24 Schmitz
1362030001	Membransylinder (DDSB) 20/30
346186001	Membransylinder (DDSB) 18/24

1351624004

123300001

125160001

1352024003



1362030001

346186001

123200001
123240001

123120002



Heve / senkeventiler

Heve / senkeventiler

Material (no)	Material korttekst
338051101	Heve / senkeventil
338051111	Hev/ senk ventil Haldex COLAS
338051121	Heve / senkeventil
338058101	Heve / senkeventil
338058121	Haldex
338059101	Heve / senkeventil

338051101



338051121



338058101



338058121



338059101



338062201



338071101



Nivåregulatorventiler

Nivåregulatorer

Material (no)	Material korttekst
612032001	Nivåventil Grau m/høydebegrensing
612035021	Nivåregulatorventil
612035031	Nivåregulatorventil
612035051	Nivåregulator Haldex
612035071	Nivåregulatorventil
612046211	Nivåregulator m/ to kjørehøyder Haldex
612046461	Nivåregulatorventil
612048131	Nivåregulatorventil
612057001	Nivåregulatorventil
612025001	Rep sett for nivåregulatorventil ledd
003575709	Rep sett nivåventil

612025001

612035021
612035031
612035071

612046461

612048131



612057001



Raufoss forskruvninger

Overgang push-in tube sealing plug



Material (no)	Material korttekst
7221	Rørplugg 6 x 1.0mm
7371	Rørplugg 12 x 1.5mm

Overgang push-in med 24 grader kon



Material (no)	Material korttekst
7202	Overgang 6x1.0mm-12x1.5mm

Rørskjøt



Material (no)	Material korttekst
7195	Rørskjøt 4x1mm
7205	Rørskjøt 6x1mm
7225	Rørskjøt 8x1mm
7265	Rørskjøt 9x1,5mm-9x1,5mm
7305	Rørskjøt 10x1mm
7315	Rørskjøt 10x1,25mm
7325	Rørskjøt 10x1,5mm
7355	Rørskjøt 11x1.5mm-11x1.5mm
7365	Rørskjøt 12x1,5mm
7445	Rørskjøt 15x1,5mm
7465	Rørskjøt 16x 2,0mm
7475	Rørskjøt 18x2.0mm
7115	Rørskjøt 1/4-1/4
7135	Rørskjøt 3/8-3/8
7155	Rørskjøt 1/2-1/2
7175	Rørskjøt 5/8-5/8

Overgang push-in kobling



Material (no)	Material korttekst
7190	Overgang 4x1mm-10mm
7192	Overgang 4x1mm-12x1mm
7201	Overgang 6mm x 1/8
7203	Overgang 6x1.0mm - 1/4"
7210	Overgang 6x1mm-10x1mm
7212	Overgang 6x1mm-12x1,5mm
7214	Overgang 6x1mm-14x1,5mm
7216	Overgang 6x1mm-16x1,5mm
7217	Overgang 6x1mm-22x1,5mm
7223	Overgang 8x1mm - 1/4"
7233	Overgang 8x1mm - 3/8"
7230	Overgang 8x1mm-10x1mm
7232	Overgang 8x1mm-12x1,5mm
7234	Overgang 8x1mm-14x1,5mm
7236	Overgang 8x1mm-16x1,5mm
7237	Overgang 8x1mm-22x1,5mm
7262	Overgang 9x1.5mm-12x1.5mm
7300	Overgang 10x1mm-10x1.5mm
7302	Overgang 10x1mm-12x1,5mm
7304	Overgang 10x1mm-14x1,5mm
7306	Overgang 10x1mm-16x1,5mm
7307	Overgang 10x1mm-22x1,5mm
7322	Overgang 10x1,25mm- R 3/8"
7312	Overgang 10x1,25mm-12x1,5mm
7314	Overgang 10x1.25mm-14x1.5mm
7316	Overgang 10x1,25mm-16x1,5mm
7317	Overgang 10x1,25mm-22x1,5mm
7323	Overgang 10x1,5mm-1/4 npt
7330	Overgang 10x1,5mm-10x1,0mm
7332	Overgang 10x1,5mm-12x1,5mm
7334	Overgang 10x1,5mm-14x1,5mm
7336	Overgang 10x1,5mm-16x1,5mm
7337	Overgang 10x1,5mm-22x1,5mm
7356	Overgang 11x1,5mm-16mm
7370	Overgang 12x1,5mm-10x1mm
7363	Overgang 12mm - 1/4"
7372	Overgang 12x1,5mm-12x1,5mm
7374	Overgang 12x1,5mm-14x1,5mm
7376	Overgang 12x1,5mm-16x1,5mm
7377	Overgang 12x1,5mm-22x1,5mm

Material (no)	Material korttekst
7444	Overgang 15x1,5mm-14x1.5mm
7446	Overgang 15x1,5mm-16mm
7447	Overgang 15x1,5mm-22mm
7451	Overgang 15x1,5mm-26x1,5mm
7448	Overgang 15x2mm-16x1,5mm
7452	Overgang 16x2mm-12x1,5mm
7456	Overgang 16x2mm-16x1,5mm
7457	Overgang 16x2mm-22x1,5mm
7468	Overgang 16x2mm-26x1,5mm
7476	Overgang 18x2mm-16x1.5mm
7477	Overgang 18x2mm-22x1.5mm
7478	Overgang 18x2mm-26x1,5mm
7101	Overgang 1/4-1/8Npt
7102	Overgang 1/4-1/4Npt
7112	Overgang 1/4-12x1,5mm
7114	Overgang 1/4-14x1,5mm
7116	Overgang 1/4-16x1,5mm
7122	Overgang 3/8-1/4Npt
7124	Overgang 3/8-3/8Npt
7125	Overgang 3/8-1/2Npt
7130	Overgang 3/8-10x1.0mm
7132	Overgang 3/8-12x1,5mm
7134	Overgang 3/8-14x1,5mm
7136	Overgang 3/8-16x1,5mm
7142	Overgang 1/2-1/4Npt
7145	Overgang 1/2-1/2Npt
7152	Overgang 1/2-12x1,5mm
7154	Overgang 1/2-14x1,5mm
7156	Overgang 1/2-16x1,5mm
7176	Overgang 5/8-16x1,5mm

Gjennomføring P5 plug-in



Material (no)	Material korttekst
7031	Svivel P5-1/8Npt
7032	Svivel P5-1/4Npt
7033	Svivel P5-3/8Npt
7034	Svivel P5-1/2Npt P
7021	Svivel P5 G1/4"
7010	Svivel P5-M10X1 P5
7012	Svivel P5-M12X1,5 P5
7014	Svivel P5-M14X1,5 P5
7016	Svivel P5-M16X1,5
7017	Svivel P5 X M22 P5
7019	Svivel P5xM26

Gjennomføring P5 M22



Material (no)	Material korttekst
7036	Gjennomføring P5-22mm x 16mm P5

1

Gjennomføring P5 plug-in M18



Material (no)	Material korttekst
7037	Gjennomføring P5 18x1,5mm x K24 grader lang P5

Albue 90 grader P5 push-in



Material (no)	Material korttekst
6816	Albue 90gr med svivel 6x1mm - P5
6826	Albue 90gr 8x1mm- P5
6991	Albue 90gr med svivel 10x1mm-P5
6814	Albue 90gr 10x1,25mm - P5
6824	Albue 90gr 10x1,5mm-P5
6836	Albue 90gr 12x1,5mm- P5
6992	Albue 90gr med svivel 15x1,5mm-P5
6840	Albue 90gr med svivel 162,0mm-P5

1

Overgang for P5 plug- in



Material (no)	Material korttekst
7057	Overgang 22mm X P5 P5

Albue 45 grader for plug-in



Material (no)	Material korttekst
6832	Albue 45gr 16x1.5mm - P5

Albue 90 grader for plug-in



Material (no)	Material korttekst
6803	Albue 90gr 12x1.5mm - P5
6833	Albue 90gr 16x1.5mm - P5

F-Forgreining



Material (no)	Material korttekst
6845	F-Forgreining 2Xm16X1,5 P5

Kryss 3 veis L



Material (no)	Material korttekst
6804	T-Forgreining M12Xm12 P5
6834	T-Forgreining P5-M16Xm16 P5

Kryss 3 veis T

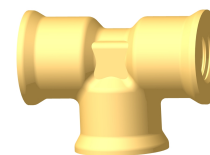

Material (no)	Material korttekst
6805	T-Forgreining M12-P5-M12
6835	T-Forgreining M16 x P5 x M16

Kryss 3 veis block

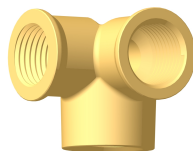

Material (no)	Material korttekst
6846	Kryss P5 M16Xm16 P5

Kryss 4 veis kryss block

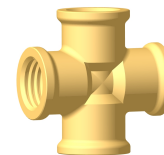

Material (no)	Material korttekst
6838	Kryss P5-M16Xm16Xm16 P5

Kryss 4 veis L block

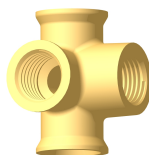

Material (no)	Material korttekst
6839	Kryss P5-M16Xm16Xm16 P5

Kryss 4 veis T block



Material (no)	Material korttekst
6837	Kryss P5-M16Xm16Xm16 P5

Albue 90 grader 2 x gjenger



Material (no)	Material korttekst
7823	Vinkel M12Xm12
7862	Vinkel M16-M16
7865	Albue 90 M18X1,5-M16X1,5
7867	Albue 90 gr M 22x1,5 innvendig

T-stykke 3 x gjenger



Material (no)	Material korttekst
7825	T-Stykke M12Xm12Xm12
7864	T-Stykke M16-M16-M16
7868	T-Stykke M22-M22-M22

1

Kryss 4 veis block



Material (no)	Material korttekst
7828	Kryss 4Xm16

Kobling med feste rett



Material (no)	Material korttekst
6933	Muffe 16x1.5mm med feste

Vinkelrør



Material (no)	Material korttekst
6934	Vinkelrør M16x1,5
6903	Vinkelrør 40 grader M16x1,5

Vinkel T- 90 grader



T-Vinkelt med brakett

Material (no)	Material korttekst
7863	T-Stykke M16Xm16Xm16

Kobling med feste 90 grader



Material (no)	Material korttekst
6935	T-stykke 90gr 16x1,5mm med feste

Gjennomføring 7722



Material (no)	Material korttekst
7722	Gjennomføring M10Xm10Xm16
1182	Gjennomføring M16x1.5 M10x1.0
7723	Gjennomføring M16x1.5 M10x1.0
7726	Gjennomføring M16-M16-M22

Gjennomføring 7622



Material (no)	Material korttekst
7622	Gjennomføring M12-M12
7693	Gjennomføring M16-M16
9116	Gjennomføring M16-1/4 R
7735	Gjennomføring M22-M16

Gjennomføring 7728

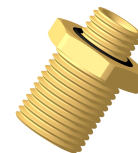

Material (no)	Material korttekst
7728	Gjennomføring M22Xm16X3/8
7729	Gjennomføring M22-M16-1/2Npt
7731	Gjennomføring M16-M16-M22
7730	Gjennomføring M22-M16-M22

1

Gjennomføring 7694



Material (no)	Material korttekst
7694	Gjennomføring M16lxm22

Gjennomføring 24 grader con 9113

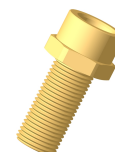

Material (no)	Material korttekst
9113	Gjennomføring M12 M/Kon X M12 Innv.
7732	Gjennomføring M18 M/Kon X M16 Innv

Albue 45 grader 7881



Material (no)	Material korttekst
7881	Vinkel 45 M22x1,5-M16x1,5

Albue 45 grader med O-ring



Material (no)	Material korttekst
8912	Vinkel 45 M16X1.5-M16X1.5 M/O-ring/mutte
8910	Vinkel 45 M16X1.5-M16X1.5 M/O-ring/mutte

Albue 90 grader



Material (no)	Material korttekst
7809	Vinkel 90 M16X1,5-M22X1,5
7880	vinkel 90 M22x1,5,M16x1,5,M22x1,5

Albue 90 grader



Material (no)	Material korttekst
7807	Albue 90gr 12x1,5mm Innv. 12x1,5mm Utv.
7808	Albue 90gr 16x1,5mm Innv. 16x1,5mm Utv.

Albue 90 grader med O-ring



Material (no)	Material korttekst
8902	Albue 90 grader 12x1,5mm med O-ring
7993	Albue 90 grader 16x1,5mm med O-ring
7998	Albue 90 grader 22x1,5mm med O-ring
9970	Albue 90 grader 26x1,5mm med O-ring

T-forgrening 7816



Material (no)	Material korttekst
7816	T-forgrening Innv 16x1.5mm utv.16x1.5mm
7875	T-forgrening 2 stk 16x1.5mm innv.22x1.5mm utv.

1

T-Forgrening

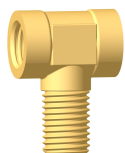

Material (no)	Material korttekst
2895	T-Forgrening M12X1,5-M16X1,5
1895	T-Forgrening M16X1,5-M16X1,5

Kryss 3 veis vinkel



Material (no)	Material korttekst
1899	Nippel M16X1,5-M16X1,5
1897	Nippel M12X1,5-M12X1,5

Låsemutter med O-ring



Material (no)	Material korttekst
7745	Låsemutter med O-ring 12x1,5mm
7746	Låsemutter med O-ring 16x1,5mm
7747	Låsemutter med O-ring 22x1,5mm

Låsemutter



Material (no)	Material korttekst
7748	Låsemutter 16x1,5mm messing
7775	Låsemutter 18x1,5mm messing
7749	Låsemutter 22x1,5mm messing
9749	Låsemutter 26x1.5mm messing

Overgangsadapter med O-ring



Material (no)	Material korttekst
7782	Overgangsadapter 12-16x1,5mm med O-ring
7784	Overgangsadapter 16-16x1.5mm med O-ring
7785	Overgangsnippel 16-18x1,5mm med O-ring
6278	Overgangsadapter 22-22x1.5mm med O-ring

Reduksjon

Material (no)	Material korttekst
7626	Overgang 1/4Npt-12mm
7628	Overgang 1/4Npt-16mm
7633	Overgang 3/8Npt-16mm
7655	Reduksjon M16-1/8Npt
7656	Overgang 16mm x1/4Npt
7657	Overgang 16mm x 3/8Npt
7614	Reduksjon M16-M12
7615	Reduksjon M22-M12
7616	Reduksjon M22-M16
7618	Reduksjon M26-M16

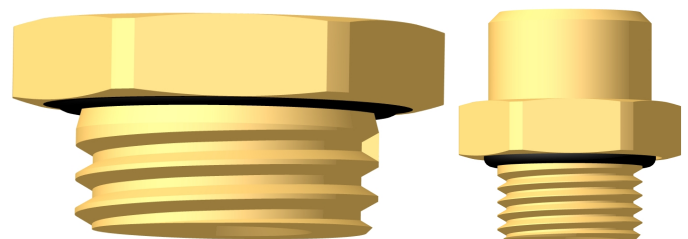

Muffe



Material (no)	Material korttekst
7741	Muffe M12
7743	Muffe M16
7744	Muffe M22

Plugg



Material (no)	Material korttekst
7605	Plugg M12
7606	Plugg M14
7607	Plugg M16
7608	Plugg M22

1

Prøveuttak



Material (no)	Material korttekst
7777	Prøveuttak M16-M22
7776	Prøveuttak M16-M16 Erst.4637031030

Prøveuttak 9144



Material (no)	Material korttekst
9144	Prøveuttak M18x1,5 M12x1,2

Prøveuttak 7207



Material (no)	Material korttekst
7207	Prøveuttak M18x1,5 6x1
7227	Prøveuttak M18x1,5 8x1

Dreneringsventil



Material (no)	Material korttekst
7787	Dreneringsventil luft m/ring M22

Slangenippel



Material (no)	Material korttekst
7905	Slangenippel 16x1,5mm Ø10
7912	Slangenippel 22x1,5mm Ø10
7906	Slangenippel 12x1,5mm Ø11
7907	Slangenippel 16x1,5mm Ø11
7915	Slangenippel 22x1,5mm Ø11
7908	Slangenippel 16x1,5mm Ø13
7914	Slangenippel 22x1,5mm Ø13
7911	Slangenippel 16x1,5mm Ø14,5
7913	Slangenippel 22x1,5mm Ø14,5

Slangenippel 8992



Material (no)	Material korttekst
8992	Slangenippel Ø9-10
8993	Slangenippel Ø11-12

Mutter for slangenippel

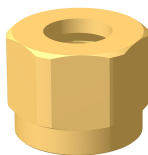

Material (no)	Material korttekst
1146	Mutter M16X1,5
1147	Mutter M18X1,5

Slangenippel plug-in P5



Material (no)	Material korttekst
7046	Slangenippel M/Sv. P5 X 011 P5

Gjennomføring



Material (no)	Material korttekst
7044	Gjennomføring M16 X P5 P5
7045	Gjennomføring M22 X P5 P5

Messing/ gummitetning



Material (no)	Material korttekst
9140	Messing / Gummi tetning 12x1,5mm
9141	Messing / Gummi tetning 14x1.5mm
9142	Messing / Gummi tetning 16x1.5mm
9143	Messing / Gummi tetning 22x1.5mm

Nippel



Material (no)	Material korttekst
7222	Raufoss / Scania nippel 6mm rør M14x1,5 inv
7382	Raufoss / Scania nippel 12 mm rør M18 x 1,5 inv

O-ring for push in plug
P5

Material (no)	Material korttekst
9081	O-ring 10x1,0mm
9089	O-ring 12x1.5mm
9088	O-ring 16x1,5mm
9086	O-ring 22x1.5mm

O-ring 8 for
låsemutter

Material (no)	Material korttekst
9094	O-ring 14x1.5mm
9092	O-ring 16x1.5mm
9086	O-ring 22x1.5mm
9084	O-ring 16x1,5mm

Hette for testnippel



Material (no)	Material korttekst
9076	Hette For Testnippel

Hansenkopling



Fordelingsblokk

Material (no)	Material korttekst
23KAIW13MPN	Hurtigkobling 1/4 innv.gj. K2-232D
23KAAK13MPN	Hurtigkobling 1/4 Utv.Gj. K2-233D
23KATF06MPN	Hurtigkobling 6 mm slange K2-23106
23KATF09MPN	Kupling 3/3 Sl.Stuss
23SFIW13SXN	Nippel 1/4 Innv.Gj. N3-232D-S
23SFAK13SXN	Nippel 1/4 Utv.Gj. N3-233D-S
23SFTF06SXN	Nippel 6mm 1/4 Slange N3-23106-S

Material (no)	Material korttekst
7767	Fordelingsblokk

Raufoss forskruvninger ABC

Push in kobling

Versjon 1



Material (no)	Material korttekst
90106010	Overgang M10x1,0 - 6x1,0
90106012	Overgang M12x1,5 - 6x1,0
90108010	Overgang M10x1,0 - 8x1,0
90108012	Overgang M12x1,5 - 8x1,0
90108014	Overgang M14x1,5 - 8x1,0
90110012	Overgang M12x1,5 - 10x1,0
90110016	Overgang M16x1,5 - 10x1,0
90110112	Overgang M12x1,5 - 10x1,25
90110116	Overgang M16x1,5 - 10x1,25
90112012	Overgang M12x1,5 - 12x1,5
90112016	Overgang M16x1,5 - 12x1,5
90115022	Overgang M22x1,5 - 15x1,5
90116016	Overgang M16x1,5 - 16x2,0
90116022	Overgang M22x1,5 - 16x2,0

Push in kobling

versjon 2

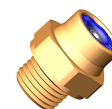

Material (no)	Material korttekst
90106014	Overgang M14x1,5 - 6x1,0
90106016	Overgang M16x1,5 - 6x1,0
90106022	Overgang M22x1,5 - 6x1,0
90108016	Overgang M16x1,5 - 8x1,0
90108022	Overgang M22x1,5 - 8x1,0
90110022	Overgang M22x1,5 - 10x1,0
90110122	Overgang M22x1,5 - 10x1,25
90112022	Overgang M22x1,5 - 12x1,5

Svivel

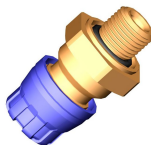

Material (no)	Material korttekst
93140010	Svivel M10x1,0 S
93140012	Svivel M12x1,5 S
93140016	Svivel M16x1,5 S
93150010	Svivel M10x1,0 M
93150012	Svivel M12x1,5 M
93150014	Svivel M14x1,5 M
93150016	Svivel M16x1,5 M
93150022	Svivel M22x1,5 M
93160016	Svivel M16x1,5 L
93160022	Svivel M22x1,5 L
93351622	Svivel M22,15/ M16x1,5 M

Rørskjøt



Rørskjøt ABC

Material (no)	Material korttekst
90508008	Rørskjøt Raufoss ABC M8X1
90506006	Rørskjøt Raufoss ABC M6X1
90512012	Rørskjøt Raufoss ABC M12x1,5

Utvendig Push inn

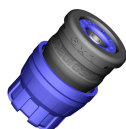

Material (no)	Material korttekst
90206004	Utvendig Push inn S 6x1
90208004	Utvendig Push inn S 8x1
90206005	Utvendig Push inn M 6x1
90208005	Utvendig Push inn M 8x1
90210005	Utvendig Push inn M 10x1,0
90210105	Utvendig Push inn M 10x1,25
90212005	Utvendig Push inn M 12x1,5
90212006	Utvendig Push inn L 12x1,5
90215006	Utvendig Push inn L 15x1,5
90216006	Utvendig Push inn L 16x2

Albue 90 grader Push-in



Material (no)	Material korttekst
90306004	Innvendig Push inn 90gr S 6x1
90308004	Innvendig Push inn 90gr S 8x1
90306005	Innvendig Push inn 90gr M 6x1
90308005	Innvendig Push inn 90gr M 8x1
90310005	Innvendig Push inn 90gr M 10x1
90310105	Innvendig Push inn 90gr M 10x1
90312205	Innvendig Push inn 90gr M 12x1
90315006	Innvendig Push inn 90gr L 15x1
90316006	Innvendig Push inn 90gr L 16x2

1

Innvendig mellomstykke 45 grade albue



Material (no)	Material korttekst
92040045	Innvendig mellomstykke 45gr S
92050045	Innvendig mellomstykke 45gr M
92060045	Innvendig mellomstykke 45gr L

Innvendig kobling 90 grader albue



Material (no)	Material korttekst
92060090	Innvendig mellomstykke 90gr L
92050090	Innvendig mellomstykke 90gr M

Innvendig F kobling



Material (no)	Material korttekst
92040015	Innvendig F kobling S
92050015	Innvendig F kobling M
92060015	Innvendig F kobling L

T-kobling



Material (no)	Material korttekst
92040010	T kobling S
92050010	innvendig T kobling M
92060010	innvendig T kobling L

Innvendig Y kobling



Material (no)	Material korttekst
92040030	Innvendig Y kobling S
92050030	Innvendig Y kobling M

Innvendig 3 veis block



Material (no)	Material korttekst
92040060	Innvendig 3 veis kobling S
92052060	Innvendig 3 veis kobling M
92060060	Innvendig 3 veis kobling L

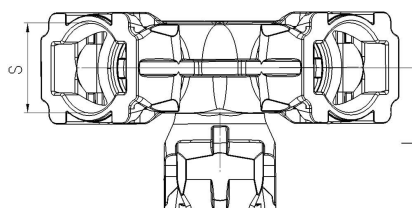

Innvendig 4 veis kobling



Material (no)	Material korttekst
92050070	Innvendig 4 veis kobling M
92060070	Innvendig 4 veis kobling L

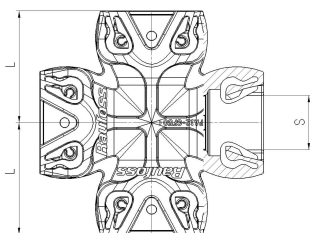

Innvendig 4 veis block

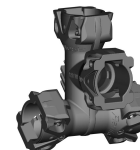

Material (no)	Material korttekst
92050061	Innvendig 4 veis kobling M
92060061	Innvendig 4 veis kobling L

Utvendig testnippel



Material (no)	Material korttekst
96050000	Utvendig testnippel M

Innvendig redusering



Material (no)	Material korttekst
96150106	Innvendig redusering L-M

Utvendig-utvendig kobling



Material (no)	Material korttekst
96540004	Utvendig-utvendig kobling S-S
96540005	Utvendig-utvendig kobling S-M
96550005	Utvendig-utvendig kobling M-M
96550006	Utvendig-utvendig kobling M-L
96560006	Utvendig-utvendig kobling L-L

Kobling 96150205



Material (no)	Material korttekst
96150205	Innvendig 3 veiskobling m/fest

1

Roteringslås

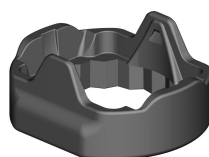

Material (no)	Material korttekst
96450020	Roteringslås M 20mm
96450022	Roteringslås M 22mm
96452028	Roteringslås M 28mm
96460022	Roteringslås L 22mm
96462028	Roteringslås L 28mm

Push in plugg



Material (no)	Material korttekst
96210016	Push inn plugg 16x2
96210015	Push inn plugg 15x1,5
96210012	Push inn plugg 12x1,5
96210008	Push inn plugg 8x1
96210006	Push inn plugg 6x1

Utvendig plugg



Material (no)	Material korttekst
96240000	Utvendig plugg S
96250000	Utvendig plugg M
96260000	Utvendig plugg L

Slangenippel

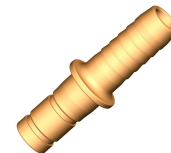

Material (no)	Material korttekst
94311012	Slangenippel 11mm

Demonteringsverktøy
compositt

Material (no)	Material korttekst
96606010	Release tool Composite 6 x 1,0
96608010	Release tool Composite 8 x 1,0 8997000014
96610010	Release tool Composite 10 x 1,0
96612710	Release tool Composite 12 x 1,5 8997000024
96615010	Release tool Composite 15 x 1,5 8997000034
96616010	Release tool Composite 16 x 2,0

Demonteringsverktøy
metall

Material (no)	Material korttekst
96608020	Release tool Metall 8 x 1,0 8997000124
96610020	Release tool Metall 10 x 1,0
96612020	Release tool Metall 12 x 1,5 8997000144
96615020	Release tool Metall 15 x 1,5 8997000154
96616020	Release tool Metall 16 x 1,5 8997000164

Bremserør / Slinger

Plastrør



Material (no)	Beskrivelse	Lengde	AT bar	PT bar	Farge
P1/2	Plastrør Sae J844	30 m	22	65	Svart
P1/4	Plastrør Sae J844	30 m	27	83	Svart
P3/8	Plastrør Sae J844	30 m			Svart
P8X5	Plastrør Sae J844D	30 m			Svart
8288769536	Plastrør M4X1	25 m			Svart
M4X1/50	Plastrør Din 73378/74324	50 m			Svart
M6X1	Plastrør Din 73378/74324	25 m	27	80	Svart
M6X1/25	Plastrør Din 73378/74324	25 m			Svart
M6X1/100	Plastrør Din 73378/74324	100 m	27	80	Svart
M8X1/25	Plastrør Din 73378/74324	25 m			Svart
M8X1/100	Plastrør Din 73378/74324	100 m	19	57	Svart
M10X1	Plastrør Din 73378/74324	30 m	15	44	Svart
M10X1/50	Plastrør Din 73378/74324	50 m			Svart
M10X1.5/50	Plastrør Din 73378/74324	50			Svart
M10X1.5	Plastrør Din 73378/74324	50 m	24	71	Svart
M11x1.5	Plastrør Din 73378/74324	30 m	21	62	Svart
M12X1.5/50	Plastrør Din 73378/74324	50 m			Svart
M15X1.5	Plastrør Din 73378/74324	30 m	12	36	Svart
M16X2	Plastrør Din 73378/74324	30 m	19	57	Svart
M16X2/100	Plastrør Din 73378/74324	100 m	19	57	Svart
M18x2	Plastrør Din 73378/74324	30 m	17	50	Svart

Bremseslanger

Gummislangen oppfyller spesifikasjoner i følge SAE J-1402 og BSAU 110. Leveres i 50 meters ruller.



Material (no)	Beskrivelse
0.68600	Bremseslange 9.5 mm SAE 1402J
68602	Bremseslange 12,5mm Sae 1402J 1601160
68604	Bremseslange 14,5Mm Sae 1402J 1601120

Slangeklemmer



Material (no)	Material korttekst
10	Flex nøkkel til slangeklemme
NR000	Slangeklemmer 9,5X12mm
NR00	Slangeklemmer 13-20mm
NR0	Slangeklemmer 16-22mm
NR0X	Slangeklemmer 18-25mm
NR1A	Slangeklemmer 20-30mm
NR1	Slangeklemmer 25-35mm
NR1X	Slangeklemmer 27-40mm
NR2A	Slangeklemmer 35-50mm
NR2	Slangeklemmer 40-55mm
NR2X	Slangeklemmer 45-60mm
NR3	Slangeklemmer 55-70mm
NR3X	Slangeklemmer 60-80mm
NR4	Slangeklemmer 70-90mm
NR4X	Slangeklemmer 85-100mm
NR5	Slangeklemmer 90-100mm
NR6	Slangeklemmer 110-140mm

1



Spiralslanger Luftspiral

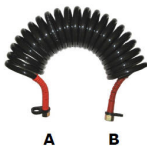

Material (no)	Beskrivelse (A)	Beskrivelse (B)	Armert
02322.1841	M18 / 1.5 (svivel)	M18 / 1.5 (svivel)	Rød
02322.1842	M18 / 1.5 (svivel)	M18 / 1.5 (svivel)	Gul

Material (no)	Beskrivelse
15332.1841	Luftspiral rød strekkavlaster 10 m arbl.
15332.1842	Luftspiral gul strekkavlaster 10 m arbl.

Luftspiral nestet



Material (no)	Beskrivelse
2522.0001	Luftspiral nestet rød+gul 4.5M

1

Håndtaksett for luftspiral

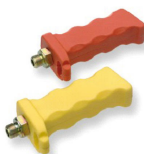

Material (no)	Beskrivelse
8939000332	Håndtaksett for luftspiral

Adapter for luftspiral

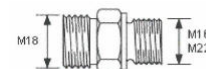

Material (no)	Beskrivelse
14000.0100	Adapter for luftspiral M22X1,5
F2181	Adapter for luftspiral M16X1,5 -M18x1,5
7785	Adapter m/ O-ring M16x1,5/ M18x1,5
14000.2600	Adapter for luftspiral M16X1,5-34Mm

WestFrost

Westfrost

West-frost er et vannabsorberende middel mot isdannelse og kondens idrivstoff- og trykkluftsystemer.

West-frost hindrer ising og fastfrysing av ventiler i trykkluft bremsesystem. Tilsatt middel som motvirker korrosjon i ventiler og tørking av pakninger.



Material (no)	Beskrivelse	Mengde
WF1	West-Frost	1liter
WF5	West-Frost	5 liter
WF25	West-Frost	25 liter
WF200	West-Frost	200 liter

Teknisk beskrivelse

West-frost beskytter mot rustdannelse i luftbeholder og bremsesør. Bruk West-frost ved temperaturer under +5. For tilhengere kan West-frost fylles i materledningen.

NB. Væskefargen er blå.

Man bør alltid følge produsentens anbefalinger.



SIKKERHETSDATABLAD

West Frost

Sikkerhetsdatabladet er i samsvar med Kommissjonsforordning (EU) 2015/830 av 28 mai 2015 om endring av europaparlaments- og rådsforordning (EF) nr. 1907/2006 om registrering, vurdering, godkjenning og begrensning av kjemikalier (REACH)

AVSNITT 1: IDENTIFIKASJON AV STOFFET/STOFFBLANDINGEN OG AV SELSKAPET/FORETAKET

Utgitt dato 09.05.2007

Revisjonsdato 12.04.2016

1.1. Produktidentifikator

Kjemikaliets navn West Frost

Artikkelnr. HC01

1.2. Identifiserte relevante bruksområder for stoffet eller stoffblandingen og bruk som det advares mot

Kjemikaliets bruksområde Frostbeskyttelsemiddel Drivstofftilsetning.

1.3. Opplysninger om leverandøren av sikkerhetsdatabladet

Produsent

Firmanavn Wilhelmsen Chemicals AS

Besøksadresse Kirkeveien 578

Postadresse P O Box 15

Postnr. 3143

Poststed KJØPMANNSKJÆR

Land Norway

Telefon +47 33351500

E-post chemicals@wilhelmsen.com

Hjemmeside <http://www.wilhelmsenchemicals.no>

Kontaktperson Kjærsti Ilebrekke - kjersti.ilebrekke@wilhelmsen.com

1.4. Nødtelefonnummer

Nødtelefon Wilhelmsen Chemicals AS: Tel.: 33 35 15 00

Giftinformasjonssentralen - 24 timer - Tlf.: 22591300

AVSNITT 2: FAREIDENTIFIKASJON

2.1. Klassifisering av stoffet eller stoffblandingen

Klassifisering i henhold til Xi, F; R11, R36, R67

67/548/EEC eller 1999/45/EC

Klassifisering i henhold til CLP (EC) Flam. Liq. 3; H225

No 1272/2008 [CLP/GHS] Eye Irrit. 2; H319

STOT SE3; H336

2.2. Merkingselementer

Farepiktogrammer (CLP)



Varselord	Fare
Faresetninger	H225 Meget brannfarlig væske og damp. H319 Gir alvorlig øyeirritasjon. H336 Kan forårsake døsighet eller svimmelhet.
Sikkerhetssetninger	P102 Oppbevares utilgjengelig for barn. P210 Holdes vekk fra varme / gnister / åpen flamme / varme overflater. — Røyking forbudt. P243 Treff tiltak mot statisk elektrisitet. P261 Unngå innånding av støv / røyk / gass / tåke / damp / aerosoler. P370 Ved brann: P280 Benytt vernehansker / verneklær / vernebriller / ansiktsskjerm. P305+P351+P338 VED KONTAKT MED ØYNE: Skyll forsiktig med vann i flere minutter. Fjern eventuelle kontaktlinser dersom dette enkelt lar seg gjøre. Fortsett skyllingen. P312 Kontakt et GIFTINFORMASJONSSENTER eller lege ved ubehag.

2.3 Andre farer

PBT / vPvB	Ingen.
Andre farer	Ingen kjente farer.

AVSNITT 3: SAMMENSETNING/OPPLYSNINGER OM BESTANDDELER

3.2. Stoffblandinger

Komponentnavn	Identifikasjon	Klassifisering	Innhold
Propan-2-ol	CAS-nr.: 67-63-0 EC-nr.: 200-661-7 Indeksnr.: 603-117-00-0	Flam. Liq. 2; H225 Eye Irrit. 2; H319 STOT SE3; H336	60 - 100 %

AVSNITT 4: FØRSTEHJELPSTILTAK

4.1. Beskrivelse av førstehjelpstiltak

Generelt	Sørg for frisk luft, varme og ro, helst i behagelig halvsittende stilling.
Innånding	Flytt straks den eksponerte til frisk luft.
Hudkontakt	Skyll med vann.
Øyekontakt	Skyll straks øynene med rikelig vann mens øyelokkene løftes. Kontakt lege hvis irritasjon vedvarer.
Svelging	Skyll munnen grundig og gi rikelige mengder melk eller vann forutsatt at den skadde ikke er bevisstløs. Kontakt lege hvis større mengder er svelget.

4.2. De viktigste symptomene og virkningene, både akutte og forsinkede

Informasjon til helsepersonell	Sørg for ro, varme og frisk luft.
--------------------------------	-----------------------------------

4.3. Angivelse av om umiddelbar legehjelp og spesialbehandling er nødvendig

Annen informasjon	Ingen spesifikke førstehjelpsforanstaltninger notert, se pkt 4.1
-------------------	--

AVSNITT 5: BRANNSLOKKINGSTILTAK

5.1. Slukkingsmidler

Passende brannslukningsmidler	Ved brannslukking benyttes alkoholresistent skum, karbondioksid eller pulver. Tørrkemikalier, sand, dolomitt e.l.
-------------------------------	---

5.2. Særlige farer knyttet til stoffet eller stoffblandingen

Brann- og eksplosjonsfarer	Damp kan danne eksplosive blandinger med luft selv ved romtemperatur. Damp er tyngre enn luft og kan spre seg langs gulvet og i bunnen av beholdere. Damp kan antennes av en gnist, en varm flate eller en glo.
----------------------------	---

5.3. Råd til brannmannskaper

Personlig verneutstyr	Bruk påkrevd personlig verneutstyr
Brannslukningsmetoder	Bruk vann for å kjøle beholdere og spre damper. Flammeutsatte beholdere kjøles med vann inntil alle brannsteder er slukket. Bruk vannspray til å avkjøle beholdere.

AVSNITT 6: TILTAK VED UTILSIKTET UTSLIPP

6.1. Personlige forsiktighetsregler, personlig verneutstyr og nødrutiner

Sikkerhetstiltak for å beskytte personell Bruk verneklær som beskrevet i punkt 8 i dette sikkerhetsdatabladet.

6.2. Forsiktighetsregler med hensyn til miljø

Sikkerhetstiltak for å beskytte ytre miljø Ikke forurens vannkilde eller kloakk.

6.3. Metoder og materialer for oppsamling og rensing

Metoder for opprydding og rengjøring Søl demmes og suges opp med sand, sagmugg eller annet absorberende materiale. Spyl området med rikelige mengder vann. Små mengder løses/fortynnes med vann og spyles til avløp.

6.4. Henvisning til andre avsnitt

AVSNITT 7: HÅNDTERING OG LAGRING

7.1. Forsiktighetsregler for sikker håndtering

Håndtering Ventilert godt. Unngå innånding av damper. Bruk godkjent åndedrettsvern dersom luftforurensningen er over akseptabelt nivå. Må ikke utsettes for varme, gnister eller åpen ild.

7.2. Vilkår for sikker lagring, herunder eventuelle uforenligheter

Oppbevaring Brannfarlig eller brennbart: Holdes adskilt fra oksiderende stoffer, varme og flammer. Oppbevares på et godt ventilert sted. Hold beholderen tett lukket.

7.3. Særlig(e) sluttanvendelse(r)

Spesielle bruksområder Identifiserte bruksområder for dette produktet er beskrevet i punkt 1.2. Kontakt leverandøren for ytterligere informasjon.

AVSNITT 8: EKSPONERINGSKONTROLL/PERSONBESKYTTELSE

8.1. Kontrollparametere

Tiltaks- og grenseverdier

Komponentnavn	Identifikasjon	Verdi	Norm år
2-Propanol	CAS-nr.: 67-63-0 EC-nr.: 200-661-7 Indeksnr.: 603-117-00-0	8 t.: 100 ppm 15 min.: 245 mg/m ³	2013

8.2. Eksponeringskontroll

Varselsskilt



Forholdsregler for å hindre eksponering

Tekniske tiltak for å hindre eksponering Sørg for tilstrekkelig generell og lokal avtrekksventilasjon.

Åndedrettsvern

Åndedrettsvern Ved høye konsentrasjoner må det brukes egnet åndedrettsvern. Gassfilter til organiske stoffer.

Håndvern

Håndvern Bruk vernehansker som tåler kjemikalier ved langvarig eller gjentatt kontakt. Nitrilgummi. Naturgummi eller plast. Hanske må velges i samarbeid med hanskeleverandøren, som kan opplyse om hanskematerialets gjennomtrengningstid.

Øye- / ansiktsvern

Øyevern Bruk sprutsikre vernebriller dersom det er mulighet for direkte øyekontakt.

Hudvern

Annet hudvern enn håndvern Bruk egnede verneklær for å beskytte mot mulig hudkontakt.

Hygiene / Miljø

Spesifikke hygienetiltak Vask straks hud som er blitt tilsøtt. Ta straks av alle klær som er blitt tilsøtt.

AVSNITT 9: FYSISKE OG KJEMISKE EGENSKAPER

9.1. Opplysninger om grunnleggende fysiske og kjemiske egenskaper

Tilstandsform	Væske
Farge	Blå
Lukt	Alkohollukt
Kokepunkt / kokepunktintervall	Verdi: ~ 82 °C
Flammepunkt	Verdi: ~ 12 °C Testmetode: TCC - Tag closed cup
Eksplisjonsgrense	Verdi: 2,5-12,7
Relativ tetthet	Verdi: 0,79 Test temperatur: 20 °C
Løselighetsbeskrivelse	Blandbar med vann
Selvantennelighet	Verdi: ~ 400

9.2. Andre opplysninger

AVSNITT 10: STABILITET OG REAKTIVITET

10.1. Reaktivitet

Reaktivitet Holdes vekk fra varme/gnister/åpen flamme/varme overflater. — Røyking forbudt.

10.2. Kjemisk stabilitet

Stabilitet Stabil under normale temperaturforhold og anbefalt bruk.

10.3. Mulighet for farlige reaksjoner

Risiko for farlige reaksjoner Ikke kjent.

10.4. Forhold som skal unngås

Forhold som skal unngås Unngå varme, flammer og andre antennelseskilder.

10.5. Uforenlige materialer

Materialer som skal unngås Ikke kjent.

10.6. Farlige nedbrytingsprodukter

Farlige spaltningsprodukter Ingen spesielle.

AVSNITT 11: TOKSIKOLOGISKE OPPLYSNINGER

11.1. Opplysninger om toksikologiske virkninger

Potensielle akutte effekter

Innånding	Gass eller damp i høye konsentrasjoner kan irritere luftveier/lunger. Løsningsmiddeldampene er skadelige og kan gi hodepine og kvalme.
Hudkontakt	Avfetter huden. Langvarig eller gjentatt kontakt fører til uttørring.
Øyekontakt	Kan virke irriterende og kan fremkalle rødhet og svie. Sprut kan medføre forbigående øyeirritasjon.
Svelging	Kan forårsake kvalme, hodepine, svimmelhet og beruselse. Dødlig dose voksen; 300-400 ml ren etanol, inntatt på ca. 1 time / 165 ml 2-propanol (anslått).

AVSNITT 12: ØKOLOGISKE OPPLYSNINGER

12.1. Giftighet

Akutt akvatisk, fisk

Verdi: > 5000 mg/l

Varighet: 96h

Økotoksisitet

Produktet inneholder ikke komponenter som er klassifisert miljøfarlige iht EU's regelverk.

12.2. Persistens og nedbrytbarhet

Persistens og nedbrytbarhet

Inngående komponenter er lett nedbrytbare (ref. OECD-test).

12.3. Bioakkumuleringsevne

Bioakkumulasjonspotensial

Produktet inneholder ikke stoffer som betraktes som bioakkumulerbare.

12.4. Mobilitet i jord

Mobilitet

Ikke ansett som mobil.

12.5. Resultater av PBT og vPvB vurdering

PBT vurderingsresultat

Klassifiseres ikke som PBT / vPvB i henhold til någjeldende EU-kriterier.

12.6. Andre skadevirkninger

Andre skadevirkninger / annen informasjon

Ikke kjent.

AVSNITT 13: DISPONERING**13.1. Avfallsbehandlingsmetoder**

Egnede metoder til fjerning av kjemikaliet

Tas opp i absorberende materiale, samles i pappdunker og forbrennes. Send større mengder til destruering. Spyl små mengder til avløp med vann. Få bekreftet rutiner for avfallsdeponering med kommuneingeniør/miljøsjeff/Miljødirektoratet og lokale forskrifter.

Avfallskode EAL

EAL: 070104 andre organiske løsemidler, vaskevæsker og morluter

AVSNITT 14: TRANSPORTOPPLYSNINGER**14.1. FN-nummer**

ADR / RID / ADN

1219

14.2. FN-forsendelsesnavn

ADR

ISOPROPANOL

RID

ISOPROPANOL

IMDG

ISOPROPANOL

ICAO/IATA

ISOPROPANOL

14.3. Transportfareklasse(r)**14.4. Emballasjegruppe**

ADR

II

RID

II

IMDG

II

ICAO/IATA

II

14.5. Miljøfarer**14.6. Særlige forsiktighetsregler ved bruk**

EmS

F-E, S-D

Spesielle forholdsregler

Ikke kjent.

14.7. Bulktransport i henhold til vedlegg II i MARPOL 73/78 og IBC-regelverket

Forurensning kategori

Cat. Z

Andre relevante opplysninger

ADR / RID / ADN Fareetikett

Class 3

IMDG Fareetikett

Class 3

ADR / RID - Annen informasjon

Tunnelbegrensningskode	(D/E)
Begrenset kvantum	1 L
Transport kategori	2

AVSNITT 15: OPPLYSNINGER OM BESTEMMELSER**15.1. Særlige bestemmelser/særskilt lovgivning om sikkerhet, helse og miljø for stoffet eller stoffblandingen**

Referanser (Lover/Forskrifter)	Council Directive 67/548/EEC Classification, packing and labelling of dangerous substances with Anx.1, List of dangerous subst. L 258A, Council Directive 1999/45/EEC Classification, packing and labelling of dangerous preparations. Regulation 1272/2008/EEC. Classification, labelling and packing of dangerous substances and preparations.
Lover og forskrifter	Administrative normer for forurensning i arbeidsatmosfære 2009, med endringer.

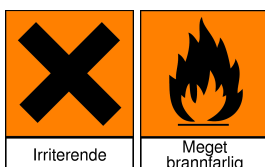
15.2. Vurdering av kjemikaliesikkerhet**AVSNITT 16: ANDRE OPPLYSNINGER****Faresymbol**

R-setninger	Meget brannfarlig. Irriterer øynene. Damp kan forårsake døsigheit og svimmelhet.
S-setninger	Emballasjen skal holdes tett lukket. Holdes vekk fra antennelseskilder - Røyking forbudt. S24/25 Unngå kontakt med huden og øynene. S26 Får man stoffet i øynene; skyll straks grundig med store mengder vann og kontakt lege. Oppbevares utilgjengelig for barn.
Leverandørens anmerkninger	Opplysningene i dette sikkerhetsdatabladet er basert på opplysninger som var i vår besittelse på det tidspunkt sikkerhetsdatabladet ble utarbeidet, og er gitt under forutsetning av at produktet anvendes under de forhold som er angitt, og i samsvar med den anvendelsesmåte som er spesifisert på emballasjen eller i relevant teknisk litteratur. Ethver annen bruk av produktet, eventuelt i kombinasjon med andre produkter eller prosesser, skjer på brukerens eget ansvar.
Klassifisering i henhold til CLP (EC) No 1272/2008 [CLP/GHS]	Flam. Liq. 3; H225; Eye Irrit. 2; H319; STOT SE 3; H336;
Liste over relevante R-setninger (i avsnitt 2 og 3).	R11 Meget brannfarlig. R36 Irriterer øynene. R67 Damp kan forårsake døsigheit og svimmelhet
Liste over relevante H-setninger (i avsnitt 2 og 3).	H225 Meget brannfarlig væske og damp. H319 Gir alvorlig øyeirritasjon. H336 Kan forårsake døsigheit eller svimmelhet.
Viktigste kilder ved utarbeidelsen av Sikkerhetsdatabladet (ikke norske)	Databladet dekker de krav som er satt i Directive 453/2010/EC
Versjon	7
Ansvarlig for Sikkerhetsdatablad	Wilhelmsen Chemicals AS
Utarbeidet av	Kjærsti Ilebrekke - Wilhelmsen Chemicals AS